

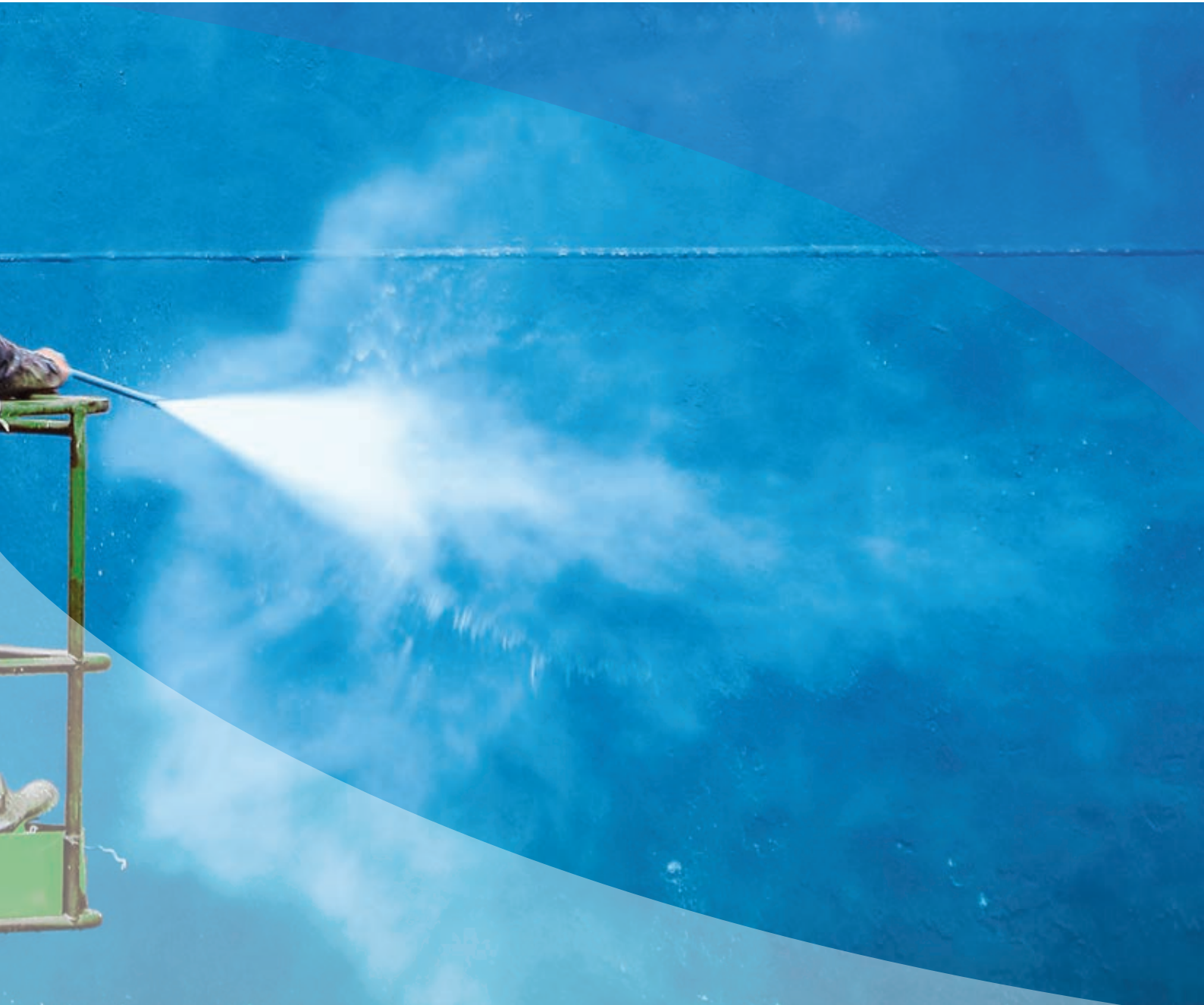

THERMOPLASTIC TUBING AND HOSES
SINCE 1961



ACQUA / WATER



Tubi per **gestione acqua**
Water handling tubing and hoses



THERMOPLASTIC TUBING AND HOSES
MADE IN ITALY

Indice / Index

Azienda / Company	6
Soluzione termoplastica: 10 vantaggi importanti / <i>Thermoplastic solution: 10 important advantages</i>	8
Le soluzioni ZEC per il passaggio di acqua / <i>ZEC solutions for water applications</i>	10
Applicazioni / <i>Applications</i>	14
Tabella di selezione / <i>Hose selection table</i>	15
Perdite di carico / <i>Pressure drop</i>	16

Soluzione termoplastica per spurgo 18 *Sewer jetting thermoplastic solution*

Tecnologia TERMOPLASTICA vs GOMMA: QUALI VANTAGGI? <i>TERMOPLASTIC vs RUBBER Technology: WHICH ADVANTAGES?</i>	19
---	----

Lavaggio e pulizia alta pressione 21 *High pressure washing and cleaning*



JC5-2500	22
----------------	----



JC5U-2500	23
-----------------	----



JC7-3000	24
----------------	----



JC7 PRO-3000	25
--------------------	----



JC7U 3000	26
-----------------	----



JC8-3600	27
----------------	----



JC8X-3600	28
-----------------	----



JC8M-5800	29
-----------------	----



JCL-5000	30
----------------	----



JET WASH 31



MT1E WATERPROOF 32

ACCESSORI E SERVIZI per pulizia delle canalizzazioni fognarie **33**
ACCESSORIES AND SERVICES for Sewer jetting applications



Guida tubolare proteggi tubo in polietilene / *Polyethylene hose protection guide* 33



Servizi / *Services* 33

Raccordi recuperabili / *Reusable fittings* 34



Raccordi One Piece / *One Piece fittings* 35

Istruzioni di sicurezza e raccomandazioni operative / *Safety instructions & recommended practices* 37

Sistemi di nebulizzazione **39**
Misting Systems



PA12 HL MISTING 40



OL7-LT 41

Acqua potabile / Alta temperatura **43**
Potable Water Handling / High Temperature



PE-LD 44



PTFE 46



FEP 48



AT7-PE 49



PTFEIP-PTFEIM-PTFEIG.....50



PTFEIC52



MT1HT-PTFE53

Accessori / Accessories 54

Indicazioni di montaggio / Installation instructions 58



ZEC S.p.A.: Flessibilità per scelta

ZEC S.p.A., fondata nel 1961 da Eugenio Zantelli a Colorno, in provincia di Parma, produce tubi termoplastici per applicazioni a bassa, media, alta e altissima pressione.

A partire dal 1990 le attività commerciali sul mercato domestico sono estese all'espansione sui mercati internazionali.

Investimenti in risorse umane particolarmente qualificate, impianti di produzione tecnologicamente avanzati, attività di ricerca e sviluppo e la presenza commerciale favoriscono l'espansione sui mercati globali, dove ZEC S.p.A. oggi è presente in più di 90 paesi.

La considerevole crescita in tutte le aree è stata accompagnata da una gamma di prodotti sempre più ampia, dedicata a numerosi settori applicativi, quali oleodinamica, pneumatica, lubrificazione, automotive, alimentare, navale, refrigerazione, petrochimico-offshore, etc..

La gamma di prodotti di ZEC S.p.A. comprende tubi termoplastici standard o customizzati singoli, multipli e spiraliati, con caratteristiche tecniche da 2mm a 40mm di diametro interno, pressioni di lavoro da 5bar a 1280bar e temperature di esercizio da -200°C a +260°C.

Tutti i tubi termoplastici di ZEC S.p.A. sono prodotti di materie prime di primaria qualità accuratamente selezionate. Ogni fase del ciclo produttivo è soggetta a severi controlli qualitativi.

La produzione avviene esclusivamente all'interno dei ns. stabilimenti a Colorno, Italia.

I prodotti finiti sono conformi alle principali normative internazionali dei rispettivi settori applicativi, quali SAE, EN, ISO e DIN.

ZEC S.p.A. opera in regime di qualità UNI EN ISO 9001-2015.

ZEC S.p.A.: Flexibility for Choice

ZEC S.p.A., founded in 1961 by Mr. Eugenio Zantelli in Colorno, Province of Parma, Italy, manufactures thermoplastic tubing and hoses for low, medium, high and very high pressure applications.

Domestic business activities are boosted by an International breakthrough as of 1990.

Investments in special skilled human resources, manufacturing, product innovations and commercial presence elevates ZEC S.p.A. meanwhile into the global market, covering more than 90 countries world-wide.

Significant growth in all areas have been accompanied with an ever increasing product range dedicated to a large portfolio of applications such as fluid power, pneumatics, lubrication, automotive, food processing, marine, refrigeration, petrochemical-offshore, and so on.

The ZEC S.p.A. product range includes standard or customized single, multiple and coiled thermoplastic tubing and hoses, with technical characteristics within the range of 2mm to 40mm inner diameter, working pressures from 5bar to 1280bar and operating temperatures from -200°C to +260°C.

All products manufactured by ZEC S.p.A. are of top quality and carefully selected raw materials. Manufacturing processes are continuously multiple controlled.

The entire production takes place in our facilities located in Colorno, Italy.

End products comply strictly with major international standards such as SAE, EN, DIN & ISO.

All company sectors and activities are qualified and operate according to UNI EN ISO 9001-2015 quality system.

Water Handling

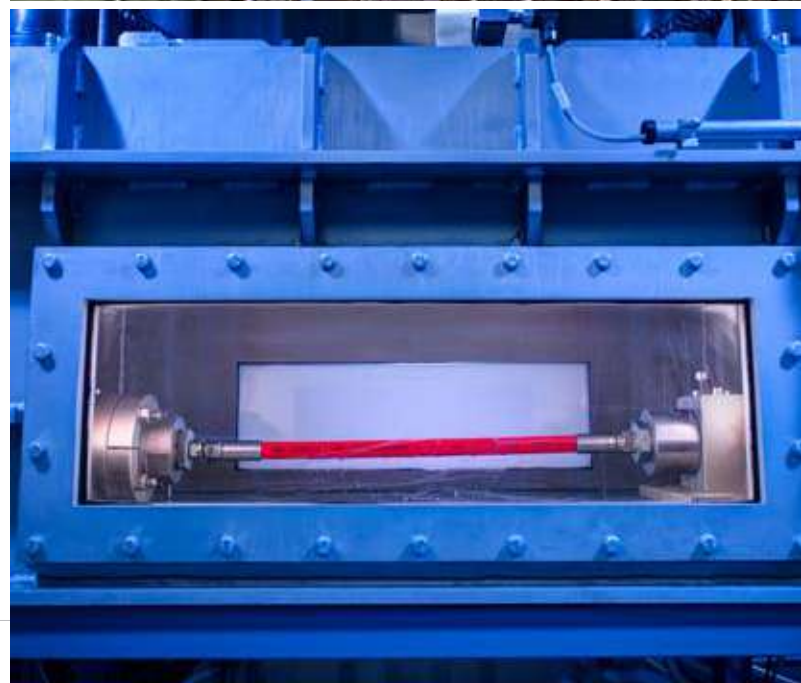
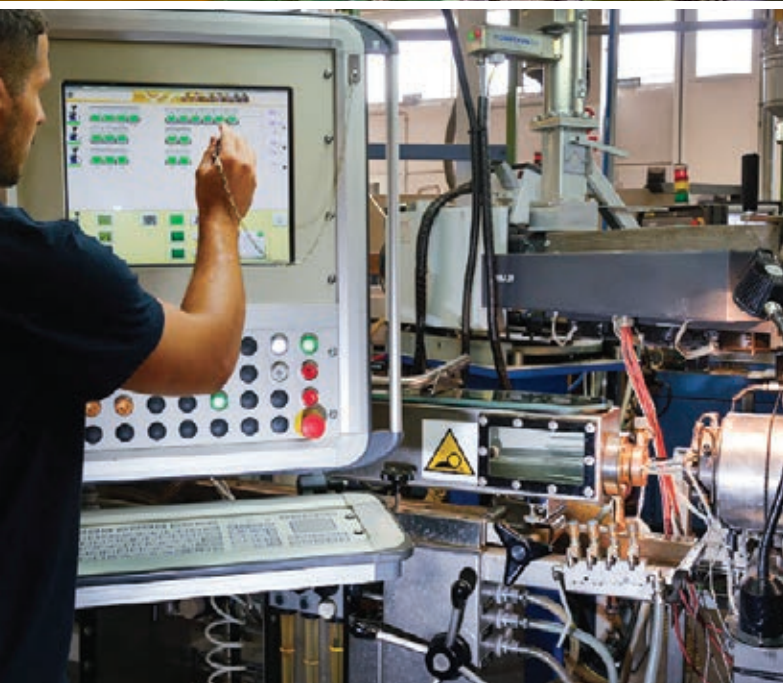

Soluzione termoplastica: 10 VANTAGGI IMPORTANTI

Thermoplastic solution: 10 IMPORTANT ADVANTAGES

I materiali e la tecnologia che stanno dietro la produzione dei tubi ZEC conferiscono ai prodotti finiti importanti vantaggi rispetto soprattutto ai tradizionali tubi flessibili in gomma:

The materials and technology behind the production of ZEC tubing and hoses, provide important advantages to finished products, especially compared to traditional rubber hoses:



Elevata resistenza all'abrasione

High abrasion resistance

La copertura esterna assicura un'elevata resistenza all'abrasione. In particolare l'utilizzo di additivi e materiali scivolanti, nonché soluzioni di adesione della ricopertura, conferiscono ai tubi termoplastici una durata di vita superiore a quelli tradizionali in gomma.

The external covering ensures high abrasion resistance. In particular the use of additives and sliding materials, as well as covering's adhesion solutions, ensure a longer service life of thermoplastic hoses compared to that of traditional rubber solutions.



Leggerezza e non conduttività

Light weight and non conductivity

Il rinforzo in fibra tessile o ibrida conferisce ai tubi termoplastici una notevole leggerezza, senza ridurne la resistenza alla pressione (riduzione di peso fino a 70% rispetto alla gomma). Inoltre i tubi con rinforzo tessile sono gli unici che rispondono allo standard ANSI A92.2.

Reinforcement made of textile or hybrid fibers makes the thermoplastic hose remarkably light, without reducing its pressure resistance (weight reduction up to 70% compared to rubber). Furthermore textile braided thermoplastic hoses are the only ones meeting the ANSI A92.2 standard.



Resistenza agli agenti atmosferici / durata a magazzino

Resistance to environmental agents / long shelf-life

La copertura esterna in materiali antiabrasione, stabilizzata ai raggi UV e resistente all'idrolisi e ai microrganismi, rende i tubi termoplastici adatti anche ad applicazioni all'esterno, in ambienti particolarmente umidi e salini, con alte e basse temperature. Inoltre è una garanzia di stabilità nel tempo, anche a magazzino.

External cover in antiabrasion materials, UV rays stabilized and resistant to hydrolysis and micro-organisms, makes thermoplastic hoses suitable for outdoor applications, in extremely humid and saline environments, and high and low temperatures. It also ensures a guarantee for long term shelf-life.



Elevata resistenza chimica

High chemical resistance

L'utilizzo di diversi materiali per le anime interne dei tubi, consente poi l'impiego anche con oli, emulsioni e polioli particolarmente aggressivi. (V. tabella di compatibilità chimica disponibile su: www.zecspa.com/it/supporto-tecnico).

The option to use different materials for the hoses inner core, makes them suitable for several applications, handling also aggressive oils, polyols and emulsions. (See chemical compatibility chart available on: www.zecspa.com/en/technical-support).

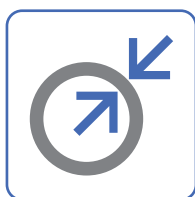

Compattezza e ridotta espansione volumetrica *Compactness and reduced volumetric expansion*

I tubi termoplastici possono avere un diametro esterno molto ridotto, a parità di pressione di esercizio, rispetto ai tradizionali tubi in gomma. Inoltre, grazie alla loro struttura, assicurano una minor espansione volumetrica a parità di pressione.

Thermoplastic hoses can have a very small outer diameter, at same working pressure, compared to traditional rubber hoses.

Moreover they ensure a lower volumetric expansion, at same pressure rate.

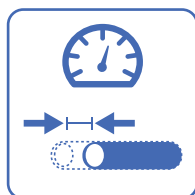

Minori perdite di carico ed allungamento in pressione *Lower pressure drops and elongation under pressure*

La superficie liscia e compatta del tubo interno riduce al minimo l'attrito del fluido, così come possibili turbolenze e surriscaldamenti. ZEC prevede sulla propria gamma una percentuale massima di allungamento di +/- 1,5% (la metà rispetto ai tubi tradizionali).

The smooth and compact inner core tubing surface, reduces fluid friction to a minimum, avoiding turbulences and overheatings.

ZEC standard maximum elongation is +/-1,5% (50% of traditional rubber hoses).

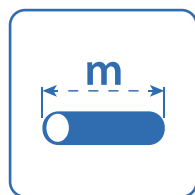

Pezzature lunghe *Long lengths*

Per alcune linee di prodotto, i tubi termoplastici possono essere prodotti in lunghezze continue fino ad oltre 1000 metri, in funzione del diametro.

For some product series, thermoplastic hoses can be manufactured in continuous lengths up to over 1.000 meters (over 3000ft), depending on size.



Multitubi paralleli e soluzioni ombelicali *Multiple hoses in parallel and umbilical solutions*

È possibile accoppiare fino a 6 tubi in composizione parallela, generando una soluzione con ingombri limitati. Inoltre ZEC è in grado di fornire soluzioni ombelicali, se necessario includendo anche cavi elettrici.

ZEC offer multiple parallel solutions up to 6 hoses, reducing the overall dimensions. ZEC is also able to offer umbilical solutions, including also electrical cables, if required.



Flessibilità su personalizzazione ed imballi *Flexibility on customization and packaging*

La soluzione termoplastica ZEC si presta alle personalizzazioni, con possibilità di un'ampia gamma di colori, ma anche lunghezze personalizzate e bobine per pezzature lunghe.

ZEC thermoplastic solutions are easily customizable, offering a huge variety of colours, customized lengths and reels for long lengths.



La soluzione idonea per gas *Appropriate solution for gas handling*

Grazie all'uso di specifici materiali, il livello di permeabilità dei tubi termoplastici è di gran lunga inferiore a quello dei tradizionali tubi in gomma. ZEC dispone di uno specifico banco prova per test con gas inerte fino a 500 bar.

The use of specific materials limits the permeability level of thermoplastic hoses compared to that of traditional rubber hoses. ZEC has a specific test bench for tests with inert gas up to 500 bar.

Le soluzioni ZEC per il passaggio di acqua

Il continuo sviluppo di agglomerati urbani e quindi delle canalizzazioni, del settore cantieristico e dell'industria alimentare porta con sé la necessità di processi di pulizia e manutenzione, spesso anche legati a ragioni igienico-sanitarie.

Questa gamma nasce per rispondere alle necessità di questi settori, sempre più esigenti anche in termini di prestazioni. Per questo lo sviluppo dei prodotti oggi a catalogo è avvenuto nel tempo e grazie alle tante aziende che hanno collaborato a testare e validare questi prodotti sul campo.

Caratteristiche e benefici:



**ESTREMA LEGGEREZZA
E MANEGGEVOLEZZA**



**ELEVATA SCIVOLOSITÀ
E FACILITÀ DI TRAINO**



**RESISTENZA ALL'USURA
E AL TAGLIO, GRAZIE AI
RIVESTIMENTI ANTI-ABRASIONE**



**RESISTENZA ALL'IDROLISI,
AI RAGGI UV, ALL'OZONO
E AI MICRORGANISMI**



**DISPONIBILITÀ IN
PEZZATURE LUNGHE**

NORMATIVA

Il settore acqua non è regolato da normative specifiche.

ZEC ha deciso comunque di presentare soluzioni conformi alla **SAE J517**, tenendo presente che il fattore di sicurezza richiesto per applicazioni con acqua è 1:2.5 come da ISO 7751.

Inoltre le specifiche esigenze del settore ci hanno imposto di effettuare particolari prove come il test di abrasione (**ISO 6945:2001**), il test di espansione volumetrica e il test di flessibilità.

APPLICAZIONI

La gamma dei tubi per gestione acqua è stata sviluppata per molteplici settori industriali, che comprendono le seguenti applicazioni:



**PULIZIA DELLE
CANALIZZAZIONI FOGNARIE.
RETI STRADALI (JC5/JC7/JC8)
E DOMESTICHE (JCL)**



**IDROPULITRICI PER APPLICAZIONI INDUSTRIALI
E PER LAVAGGIO AUTO (JC5/JC7/JC8/JCL/
MT1E/JET WASH)**



**SISTEMI DI NEBULIZZAZIONE
PER USO AGRICOLO E
RINFRESCAMENTO (PA12HL/AT7-PE)**



PULIZIA SERRE (JC7/JET WASH)



**GESTIONE ACQUA POTABILE
(PE-LD/FEP/PTFE/PTFEIC/AT7-PE)**



**ALTA TEMPERATURA
(MT1HT-PTFE/FEP/PTFE/PTFEIC)**



OIL & GAS (JC8M-5800)



RETI PER ACQUACOLTURA (JC8X-3600)

QUALITÀ

Il sistema di qualità certificato **ISO 9001 di ZEC** assicura il continuo e costante controllo del processo di produzione, garantendo il rispetto delle buone pratiche di fabbricazione.



COMPANY WITH
QUALITY SYSTEM
CERTIFIED BY DNV
ISO 9001

Water Handling

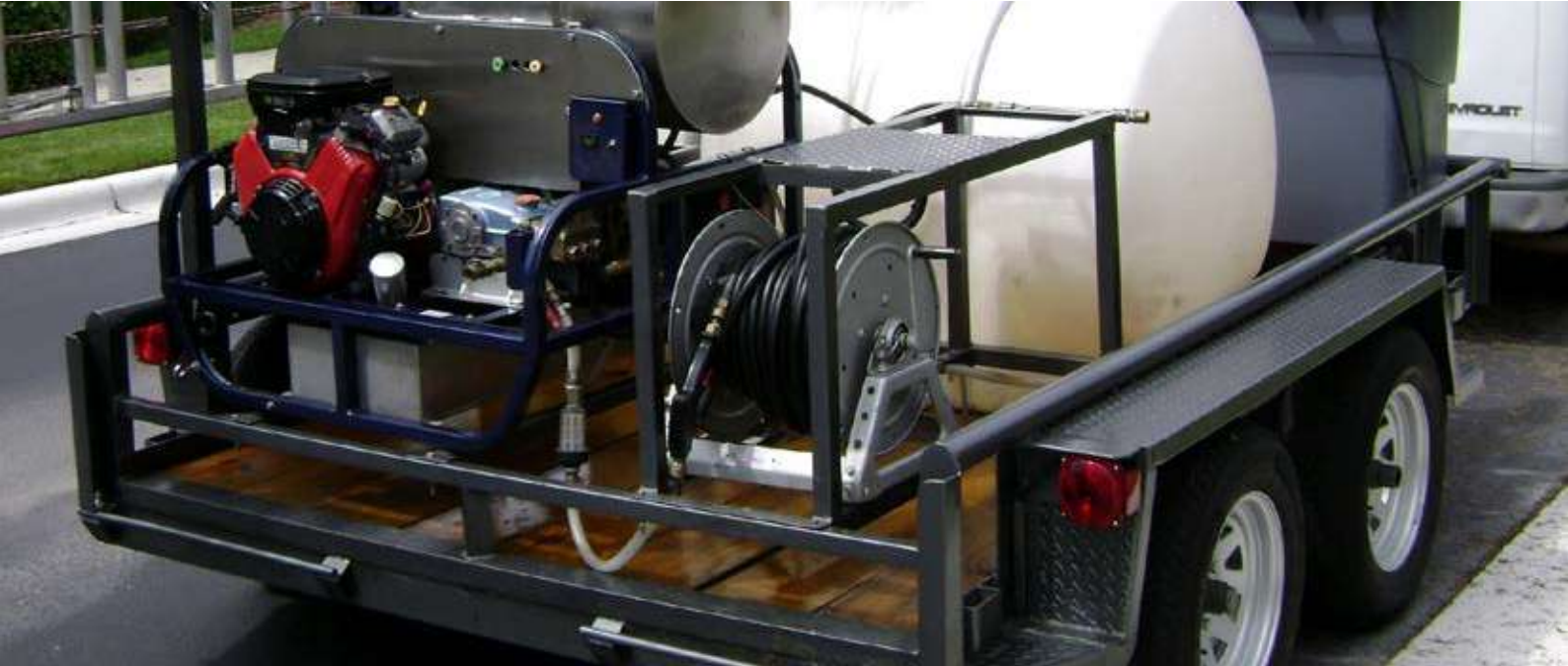

ZEC solutions for water handling

Continuous development of new urban centers and therefore their sewers, shipbuilding industry and food industry brings with it the necessity of cleaning and maintenance, very often related also to hygiene and health reasons.

This product range has been developed to meet the most demanding applications, even in terms of performance. This is the reason why the development has occurred during the years, especially thanks to the customers investing together with ZEC on field testing, enabling ZEC to validate the optimal product range for the market.

Features and benefits:



VERY LIGHT WEIGHT SOLUTION AND SO EASY HANDLING



ULTRA SLIPPERY COVER, MAKING EASY HOSE FLOATING OPERATION AND HOSE DRAGGING BY OPERATOR



HIGH ABRASION AND COVER CUTTING RESISTANCE



HIGH RESISTANCE TO HYDROLYSIS, UV RAYS, OZONE AND MICROORGANISMS



LONG LENGTHS AVAILABILITY

STANDARD Water applications aren't regulated by specific standards.

ZEC has anyway decided to present solutions tested according to **SAE J517** and using proper safety factor 1:2.5, according to ISO 7551. Moreover, specific applicational needs required us to perform particular tests, e.g. abrasion test (**ISO 6945:2001**), volumetric expansion test and flexibility test.

APPLICATIONS Water handling hose range has been developed for multiple Industrial sectors, including the following applications:



SEWER JETTING APPLICATIONS ON ROAD NETWORK (JC5/JC7/JC8) AND SECONDARY OR DOMESTIC DUCTS (JCL)



HIGH PRESSURE WASHER SYSTEMS FOR INDUSTRIAL OR CAR APPLICATIONS (JC5/JC7/JC8/JCL/MT1E/JET WASH)



MISTING SYSTEMS FOR AGRICULTURAL AND HUMAN COOLING (PA12HL/AT7-PE)



GREENHOUSE CLEANING (JC7/JET WASH)



POTABLE WATER HANDLING (PE-LD/FEP/PTFE/PTFEIC/AT7-PE)



HIGH TEMPERATURE (MT1HT-PTFE/FEP/PTFE/PTFEIC)



OIL & GAS (JC8M-5800)



NETS FOR AQUACULTURE (JC8X-3600)

QUALITY The certified **ISO 9001 ZEC** quality system ensures a continuous and constant control of the production process, guaranteeing compliance with good manufacturing practices.



COMPANY WITH
QUALITY SYSTEM
CERTIFIED BY DNV
ISO 9001

Water Handling



APPLICAZIONI / APPLICATIONS

I tubi termoplastici ZEC per il settore oleodinamico ricoprono una vasta gamma di applicazioni.
ZEC thermoplastic hoses for fluid power cover a wide range of applications.

PULIZIA DELLE CANALIZZAZIONI FOGNARIE SEWER JETTING APPLICATIONS



- Reti stradali / Road network
- Reti secondarie e domestiche / Secondary or domestic drains

TUBI / HOSES

JC5-2500
JC5U-2500
JC7-3000
JC7 PRO-3000
JC7U 3000
JC8-3600
JCL-5000

SISTEMI DI NEBULIZZAZIONE MISTING SYSTEMS

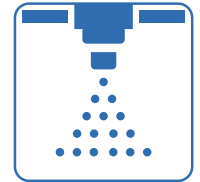

- Uso agricolo / agricultural use
- Rinfrescamento commerciale ed industriale / Commercial and industrial cooling

TUBI / HOSES

PA12 HL - MISTING
OL7-LT

IDROPULITRICI HIGH PRESSURE WASHER SYSTEMS

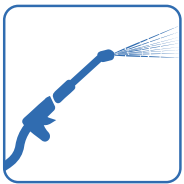

- Pulizia industriale / Industrial cleaning
- Lavaggio auto / Car washer

TUBI / HOSES

JC5-2500
JC7-3000
JC7 PRO-3000
JC8-3600
JC5-2500
JC8X-3600
JCL-5000
JET WASH
MT1E - WATERPROOF

PULIZIA SERRE GREENHOUSE CLEANING



- Lavaggio Serre / Greenhouses cleaning
- Pulizia industriale / Industrial cleaning

TUBI / HOSES

JC7-3000
JET WASH

GESTIONE ACQUA POTABILE POTABLE WATER HANDLING



- Acqua potabile / Potable water
- Alte temperature / High temperatures

TUBI / HOSES

PE-LD
FEP
PTFE
PTFEIC
AT7-PE

ALTA TEMPERATURA HIGH TEMPERATURE

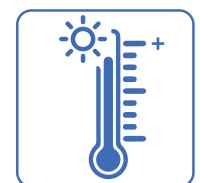

- Acqua potabile / Potable water
- Alte temperature / High temperatures

TUBI / HOSES

MT1HT-PTFE
FEP
PTFE
PTFEIC

PIATTAFORME PETROLIFERE OIL PLATFORMS



- Piattaforme Petrolifere / Oil Platforms

TUBI / HOSES

JC8M-5800

RETI PER ACQUACOLTURA NETS FOR AQUACULTURE



- Pulizia reti allevamenti ittici / Fish farms nets cleaning

TUBI / HOSES

JC8X-3600

TABELLA DI SELEZIONE / HOSE SELECTION TABLE

		PRESSIONE / PRESSURE (BAR)											COPERTURA COVER	STANDARD COLOR	PAGINA PAGE
		DN3	DN5	DN6	DN8	DN10	DN12	DN16	DN19	DN25	DN32	DN38			
SERIE		1/8"	3/16"	1/4"	5/16"	3/8"	1/2"	5/8"	3/4"	1"	1 1/4"	1" 1/2"			
PULIZIA ACQUA FREDDA COLD WATER CLEANING	JETWASH					100	100	100	100				PU: WP	GREEN	29
	JC5-2500			175		175	175		175	175	175		PU: WP	ORANGE	20
	JC5U-2500						175	175	175	175			PU: WP	ORANGE	21
	JC7-3000						275	220	207	207	207	207	PU: WP	ORANGE	22
	JC7PRO-3000						275		210				PU: WP	GREEN	23
	JC7U-3000						207	207	207	207			PU: WP	LIGHT BLUE	24
	JC8-3600						345		250	250	250		PU: WP	RED	25
	JC8X-3600								250	250	250		PU: WP	RED	26
	JC8M-5800								400	400	400		PU: WP	RED	27
	JCL-5000	345	345	345		345							PU: WP	BLACK	28
MT1E		560	480	384	360	304						PU: WP	BLACK	30	
NEBULIZZAZIONE MISTING	PA12 HL		93	95		87	87							NATURAL	36
	OL7-LT	230	210	200	190	175	140	105	90	70			PU: WP	BLACK	37
ACQUA POTABILE POTABLE WATER	PE-LD	DA/FROM OD 4,00 MM - 21BAR A/TO OD 23,00 MM - 4 BAR												MULTIPLE	40
	AT7-PE		200			175	140		90				PU: WP	BLACK	45
ALTA TEMPERATURA HOT WATER	PTFE	DA /FROM OD 3,00 MM - 56 BAR TO/FROM OD 22,00 MM - 3 BAR												MILKY	42
	FEP	DA/FROM OD 4,00 MM - 40 BAR A/TO OD 12,00 MM - 8 BAR												CLEAR TRANSP	44
	PTFE IP/IM/IG	DA/FROM OD 6,50 MM - 275 BAR A/TO OD 30,30 MM - 65 BAR													46
	PTFEIC	DA/FROM OD 15,00 MM - 120 BAR A/TO OD 63,6 MM - 36 BAR													48
	MT1HT-PTFE	DA/FROM OD 7,50 MM - 375 BAR A/TO OD 40,00 MM - 70 BAR											PU:OP	BLACK	49

LEGENDA - MATERIALI: PU = POLIURETANO OP = OIL PROOF WP = WATER PROOF

LEGEND - MATERIALS: PU = POLYURETHANE OP = OIL PROOF WP = WATER PROOF

NOTE 1: SERIE ZEC COMPLEMENTARE, RACCOMANDATA PER FLUIDI / EMULSIONI AGGRESSIVE. VEDI TABELLA DI COMPATIBILITÀ CHIMICA (www.zecspa.com/it/supporto-tecnico)
2: VEDI DATASHEET TUBI PER RANGE DI PRESSIONI ANSI (www.zecspa.com/en/products/fluid-power/non-conductive-systems/non-conductive-ol7-series)

NOTES 1: COMPLEMENTARY ZEC SERIES, RECOMMENDED FOR AGGRESSIVE FLUIDS/EMULSIONS. SEE CHEMICAL COMPATIBILITY CHART (www.zecspa.com/en/technical-support)
2: VIEW HOSE DATASHEET FOR ANSI PRESSURE RATINGS (www.zecspa.com/en/products/fluid-power/non-conductive-systems/non-conductive-ol7-series)

Perdite di carico / Pressure drop

Lunghezza del tubo / Hose length = — 50 m — 100 m — 150 m — 200 m

DN 12

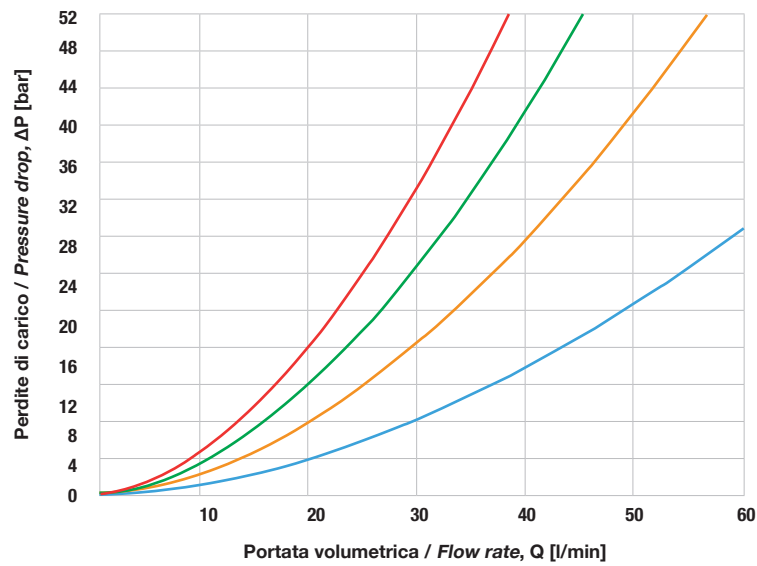

DN 16

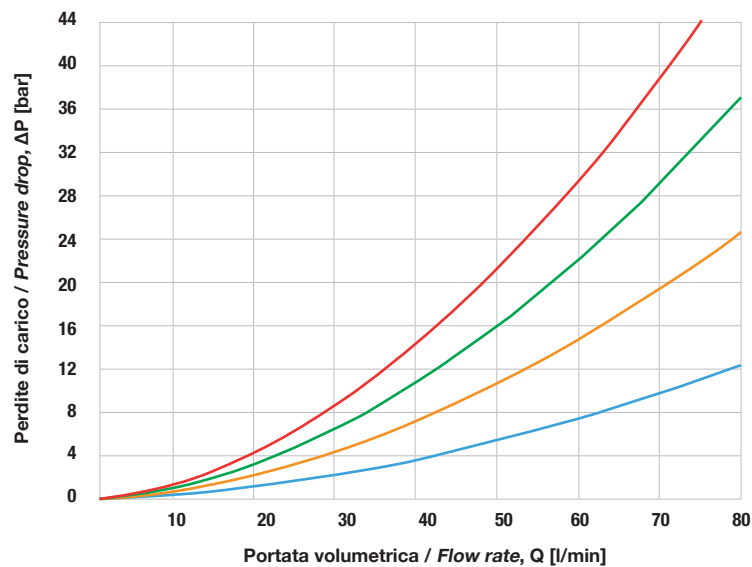

DN 19

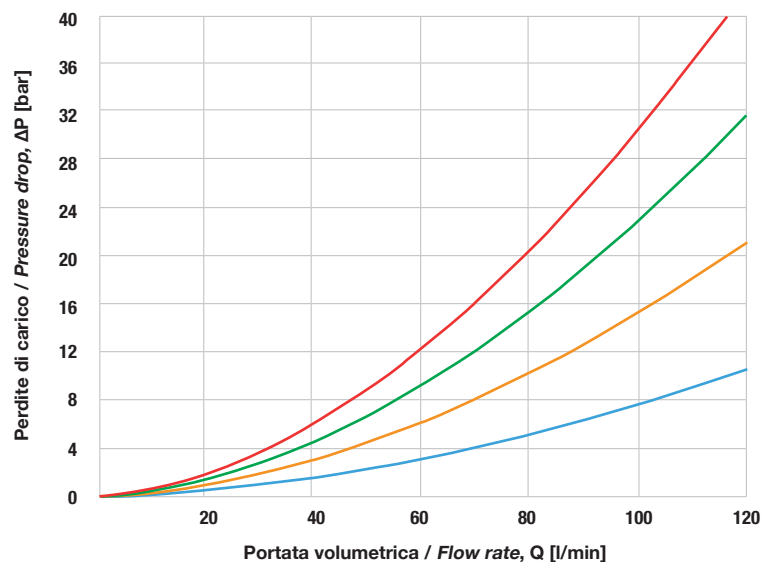

NB: i grafici si riferiscono a calcoli teorici effettuati considerando il passaggio di acqua a 23°C. Le effettive perdite di carico possono variare a seconda delle reali condizioni di impiego. I valori forniti sono esenti da responsabilità.

NOTE: the graphs refer to theoretical calculations carried out considering the passage of water at 23°C. The real pressure losses may vary according to the real conditions of use. Values provided are without liability.

Perdite di carico / Pressure drop

Lunghezza del tubo / Hose length = — 50 m — 100 m — 150 m — 200 m

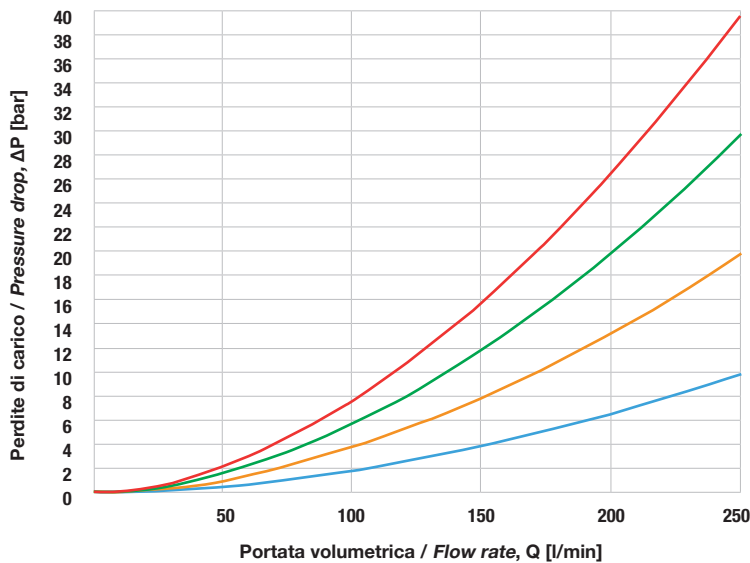

DN 25

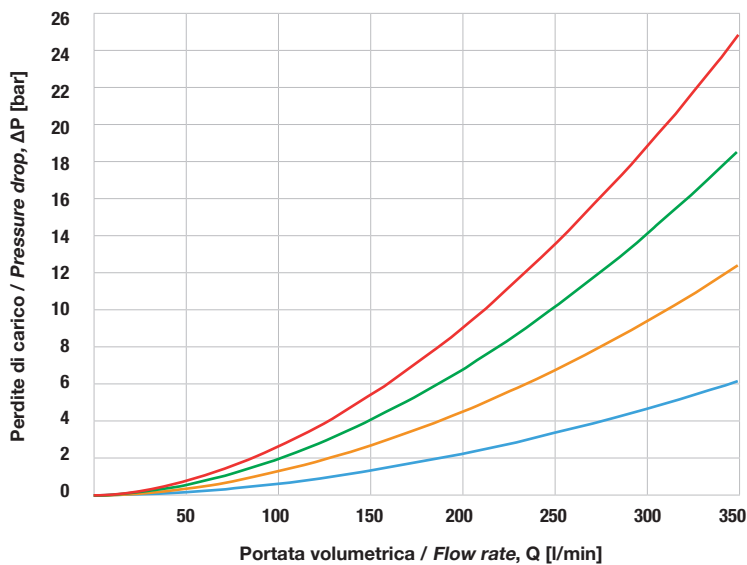

DN 32

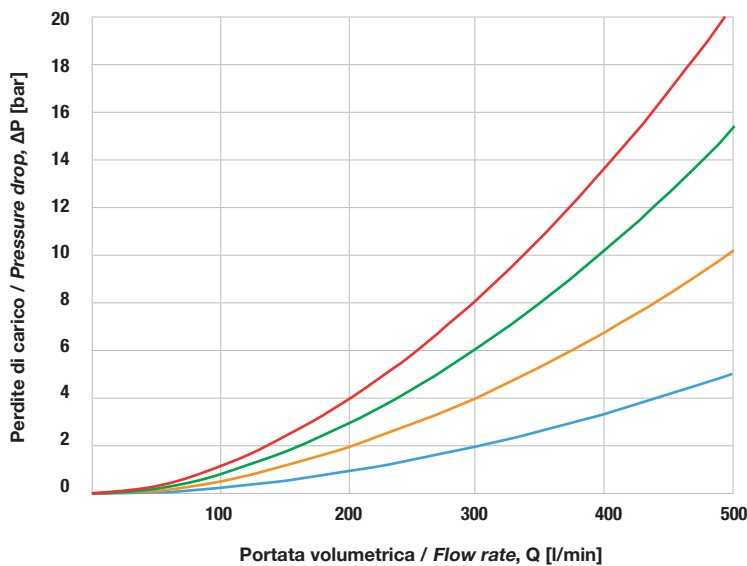

DN 38

NB: i grafici si riferiscono a calcoli teorici effettuati considerando il passaggio di acqua a 23°C. Le effettive perdite di carico possono variare a seconda delle reali condizioni di impiego. I valori forniti sono esenti da responsabilità.

NOTE: the graphs refer to theoretical calculations carried out considering the passage of water at 23°C. The real pressure losses may vary according to the real conditions of use. Values provided are without liability.

Tubo termoplastico per applicazione spurgo e pulizia canalizzazioni *Thermoplastic hose for sewer jetting and cleaning application*

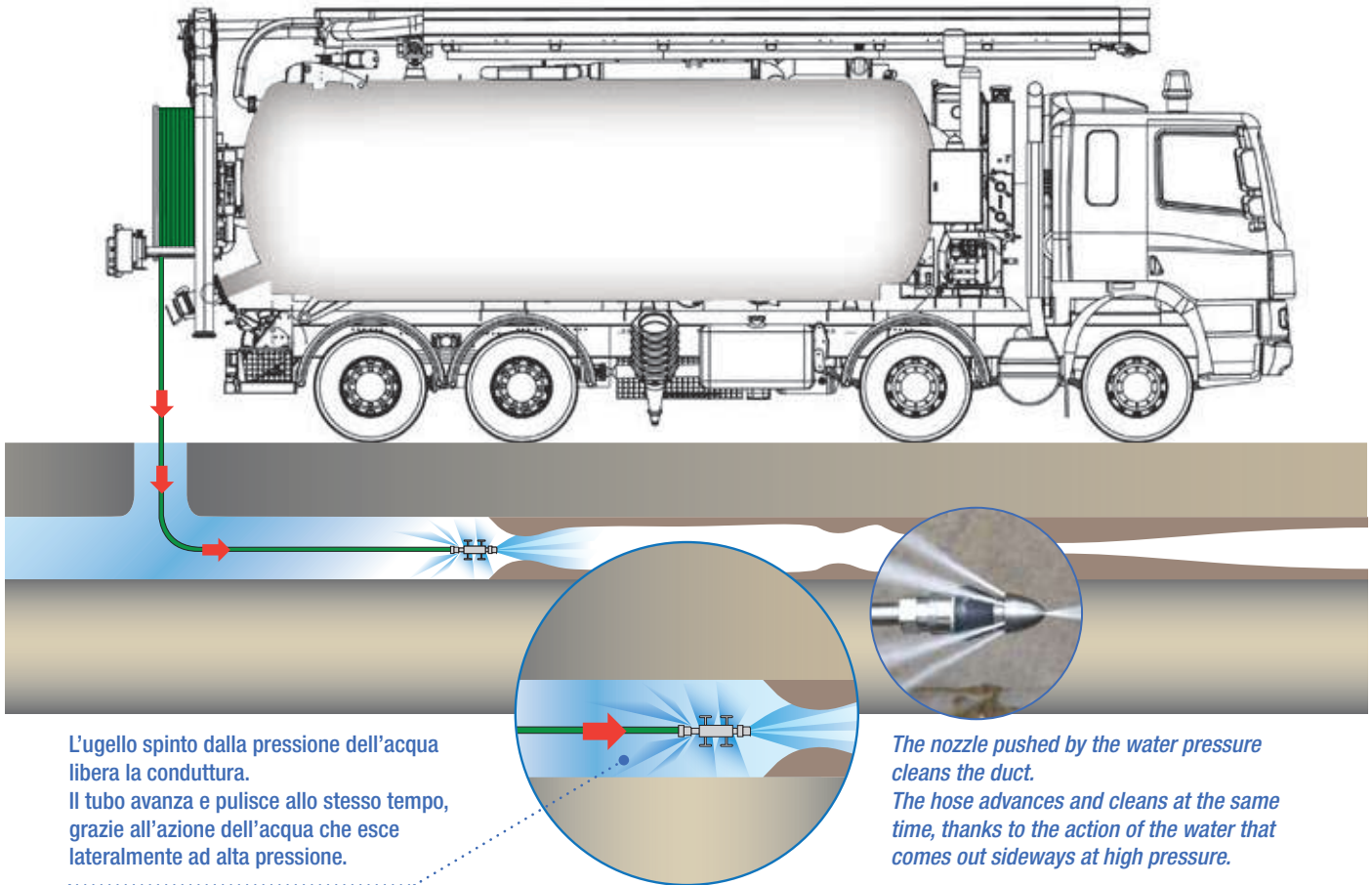

Tecnologia TERMOPLASTICA vs GOMMA: QUALI VANTAGGI? TERMOPLASTIC vs RUBBER TECHNOLOGY: WHICH ADVANTAGES?

La soluzione termoplastica per quest'applicazione risulta essere quella maggiormente in crescita su tanti mercati a livello mondiale. La praticità di utilizzo e la sicurezza di questa soluzione, unita anche al tema del risparmio energetico, sono punti importanti di interesse tanto per costruttori di automezzi per spurgo, quanto per utilizzatori finali.

Thermoplastic solution represents today the most growing hose technology for sewage application on several areas around the world. The ease of use and safety, together with operation's speed and energy saving are very interesting points today for OEMs but especially for End Users.

1. Risparmio di tempo, risparmio energetico e minor impatto ambientale *Time saving, energy saving and lower environmental impact*

SPECIFICHE TECNICHE

- Limitata espansione = **Maggiore efficienza**
- Superficie interna liscia = **Minori perdite di carico**
- Superficie esterna scivolosa = **Usura limitata e durata di vita superiore**
- Peso inferiore = **Maggior velocità del tubo**

TECHNICAL SPECIFICATIONS

- *Minimum volumetric expansion = **Higher efficiency***
- *Smooth inner bore = **Minimum pressure losses***
- *Sliding external surface = **Limited wearing and Longer lifetime***
- *Lower weight = **Higher hose speed***

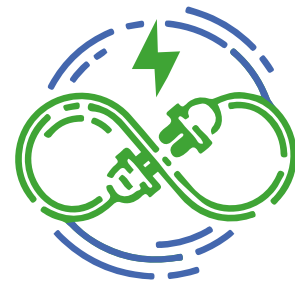

Le caratteristiche del tubo facilitano l'utilizzo e riducono i tempi operativi.

Il tubo ZEC risulta più scorrevole, molto più leggero e di conseguenza l'operazione di pulizia più rapida.

Tutto questo si traduce in: risparmio di acqua, risparmio di carburante, abbattimento dei costi di intervento.

Thermoplastic hose characteristics make it easy to use and reduce operating time.

ZEC hose is smoother and much lighter, thus entire operation process faster.

All this results in: water saving, fuel saving, total operation cost reduction.

2. Praticità e sicurezza per l'operatore *Convenience and safety for the operator*

SPECIFICHE TECNICHE

- Limitato allungamento in pressione ($\pm 0.5\%$)
- Elevata resistenza alla torsione ed al kinking
- Elevata compatibilità chimica
- Assenza rinforzo in acciaio

TECHNICAL SPECIFICATIONS

- *Limited elongation during pressurization ($\pm 0.5\%$)*
- *High kinking and torsion resistance*
- *High Chemical resistance*
- *Absence of steel reinforcement*



La soluzione ZEC risulta quindi pratica e veloce in fase di srotolamento e riavvolgimento, anche nel caso di operazioni complesse e con utilizzo di eventuali sanificanti. La presenza inoltre di fibra tessile di rinforzo garantisce sicurezza ed affidabilità all'operatore.

ZEC solution results more practical and fast during unrolling and rolling-up operations, even on complicated cases and use of sanitizers. Moreover, the use of fabric reinforcement is a guarantee of safe and reliability for the operator.

3. Personalizzazione prodotto ed imballo *Product and presentation customization*

SPECIFICHE TECNICHE

- Lunghezza pezzature anche oltre i 300mt
- Personalizzazione colore
- Personalizzazione imballi
- Opzione raccordatura certificata ZEC
- Disponibilità di accessori e linee guida per uso corretto

TECHNICAL SPECIFICATIONS

- *Maximum lengths ofer 300 meters*
- *Wide range of colors availables*
- *Selection of reels*
- *ZEC certified crimping solution as option*
- *Complementary accessories and proper guidelines*

Soluzioni a misura delle richieste di mercato ed esigenze di OEM ed utilizzatori finali

Tailored made solution according to OEMs requirements and End Users demands



Lavaggio e pulizia alta pressione
High pressure washing and cleaning



JC5-2500



Caratteristiche principali

- Pressione di lavoro costante a 175 bar / 2.500 psi
- Eccezionale scivolosità e resistenza all'abrasione
- Limitate espansione volumetrica e perdite di carico
- Elevata velocità di avanzamento e galleggiamento

Main features

- Constant working pressure at 175 bar / 2.500 psi
- Super sliding and abrasion resistant
- Low volumetric expansion and pressure drop
- High operating speed and floatation

Caratteristiche tecniche

Caratteristiche tecnico-costruttive:

Anima interna in compound termoplastico, rinforzo con doppia treccia in fibra di poliestere e rivestimento esterno in poliuretano antiabrasione, resistente all'idrolisi e stabilizzato per applicazioni all'esterno, in ambienti particolarmente umidi e salini.

Applicazioni:

Le tubazioni della serie JC5 sono state create per passaggio acqua nel settore della pulizia a media pressione.

Temperature di utilizzo:

da -40°C a +55°C (-40°F a +131°F)

Pressioni d'esercizio:

rapporto di sicurezza 1:2.5

Lunghezza pezzature:

disponibili secondo necessità, fino a 350 metri.

Technical Features

Technical-constructive features:

Inner core in thermoplastic compound, reinforcement in double polyester textile braid and cover in antiabrasion polyurethane, resistant to hydrolysis and stabilized for outdoor applications, in environments with high humidity and saline levels.

Applications:

The JC5 Series hoses have been created for water applications in the medium pressure cleaning field.

Working temperature:

from -40°C to +55°C (-40°F to 131°F)

Working pressure:

Safety ratio 1:2.5

Reels length:

Available upon request, up to 350mts.

Scheda tecnica - Data Sheet



CODE	inch	-dash	mm	DN	inch	mm	bar	psi	mm	inch	g/m	lbs/ft	FERRULE CODE
JC537101	1/4"	-4	6.4	6	0.500	12.7	175	2540	60	2.36	83	0.056	BP14MT1
JC557101	3/8"	-6	9.7	10	0.630	16.0	175	2540	90	3.54	132	0.089	BP38R7V
JC567101	1/2"	-8	13.0	12	0.827	21.0	175	2540	95	3.74	210	0.141	BP12R7V
JC587101	3/4"	-12	19.2	19	1.161	29.5	175	2540	120	4.72	380	0.255	BP34JC7
JC597101	1"	-16	25.6	25	1.456	37.0	175	2540	150	5.91	555	0.373	BP1JC7
JC5107101	1" 1/4	-20	32.0	32	1.799	45.7	175	2540	235	9.25	885	0.595	BP114JC7

JC5U-2500

AMERICAN STANDARD



Caratteristiche principali

- Pressione di lavoro 175 bar / 2.500 psi
- Eccezionale resistenza a kinking, torsione e schiacciamento
- Compatibilità con raccordi ed accessori in uso sul mercato

Main features

- Working pressure from 175 bar / 2.500 psi
- High kinking, torsion and flattening resistance
- Compatibility with fittings and accessories standard on market

Caratteristiche tecniche

Caratteristiche tecnico-costruttive:

Anima interna compound termoplastico, rinforzo con doppia treccia in filato poliestere e rivestimento esterno in poliuretano antiabrasione, microforato, stabilizzato ai raggi UV e resistente all'idrolisi, per applicazioni all'esterno, in ambienti particolarmente umidi e salini.

Applicazioni:

Le tubazioni della serie JC5U sono state create per passaggio acqua nel settore della pulizia ad alta pressione.

Temperature di utilizzo:

da -40°C a +55°C (-40°F a +131°F)

Pressioni d'esercizio:

rapporto di sicurezza 1:2.5

Variazione longitudinale:

+/- 1.5%

Lunghezza pezzature:

disponibili secondo necessità, fino a 350 metri.

Technical Features

Technical-constructive features:

Inner core in thermoplastic compound, double braided polyester fiber reinforcement and outer covering in antiabrasion polyurethane, pin-pricked, stabilized to UV rays and resistant to hydrolysis for outdoor applications, in environments having high humidity and saline levels.

Applications:

The JC5U Series hoses have been created for water applications in the high pressure cleaning field.

Working temperature:

from -40°C to +55°C (-40°F to 131°F)

Working pressure:

Safety ratio 1:2.5

Length variation:

+/- 1.5%

Reels length:

Available upon request, up to 350mts.

Scheda tecnica - Data Sheet



CODE	inch	-dash	mm	DN	inch	mm	bar	psi	bar	psi	mm	inch	g/m	lbs/ft	FERRULE CODE
JC5U67101	1/2"	-8	12.7	13	0.799	20.3	175	2540	438	6350	140	5.512	296	0.199	BP12R7V
JC5U77101	5/8"	-10	16.0	16	0.961	24.4	175	2540	438	6350	140	5.512	379	0.255	BP34R7
JC5U87101	3/4"	-12	19.2	19	1.165	29.6	175	2540	438	6350	170	6.693	517	0.347	BP34JC7
JC5U97101	1"	-16	25.6	25	1.468	37.3	175	2540	438	6350	190	7.480	780	0.524	BP1JC7S

JC7-3000



Caratteristiche principali

- Pressione di lavoro 207 bar / 3.000 psi
- Eccezionale scivolosità e resistenza all'abrasione
- Limitate espansione volumetrica e perdite di carico
- Elevata velocità di avanzamento e galleggiamento
- Disponibile anche diametro DN38

Main features

- Working pressure 207 bar / 3.000 psi
- Super sliding and abrasion resistant
- Low volumetric expansion and pressure drop
- High operating speed and floatation
- Available also in size 1 1/2" -24

Caratteristiche tecniche

- **Caratteristiche tecnico-costruttive:**
Anima interna in compound termoplastico, rinforzo con 2 o più trecce in fibra tessile ad alta tenacità e rivestimento esterno in poliuretano antiabrasione, microforato, stabilizzato ai raggi UV e resistente all'idrolisi, per applicazioni all'esterno, in ambienti particolarmente umidi e salini.
- **Applicazioni:**
Le tubazioni della serie JC7 sono state create per passaggio acqua nel settore della pulizia ad alta pressione.
- **Temperature di utilizzo:**
da -40°C a +55°C (-40°F a +131°F)
- **Pressioni d'esercizio:**
rapporto di sicurezza 1:2.5
- **Lunghezza pezzature:**
disponibili secondo necessità, fino a 350 metri.

Technical Features

- **Technical-constructive features:**
Inner core in thermoplastic compound, 2 or more reinforcement braids in high tenacity textile fibers and outside covering in antiabrasion polyurethane, pin-pricked, stabilized to UV rays and resistant to hydrolysis for outdoor applications, in environments having high humidity and saline levels.
- **Applications:**
The JC7 Series hoses have been created for water applications in the high pressure cleaning field.
- **Working temperature:**
from -40°C to +55°C (-40°F to 131°F)
- **Working pressure:**
Safety ratio 1:2.5
- **Reels length:**
Available upon request, up to 350mts.

Scheda tecnica - Data Sheet



CODE	inch	-dash	mm	DN	inch	mm	bar	psi	mm	inch	g/m	lbs/ft	FERRULE CODE
JC767101	1/2"	-8	13.0	12	0.882	22.4	275	4000	75	2.95	277	0.186	BP12JC7
JC777101	5/8"	-10	16.0	16	1.043	26.5	220	3200	100	3.94	372	0.250	BP34JC7
JC787101	3/4"	-12	19.2	19	1.173	29.8	207	3000	120	4.72	431	0.290	BP34JC7
JC797101	1"	-16	25.6	25	1.484	37.7	207	3000	150	5.91	580	0.390	BP1JC7S
JC7107101	1" 1/4	-20	32.0	32	1.811	46.0	207	3000	235	9.25	926	0.622	BP114JC7
JC7127101	1" 1/2	-24	38.2	38	2.126	54.0	207	3000	375	14.76	1186	0.797	BP112JC7

JC7 PRO-3000

ELEVATA FLESSIBILITÀ / HIGH FLEXIBILITY



Caratteristiche principali

- Straordinaria flessibilità
- Pressione di lavoro da 200 bar / 3.000 psi a 275 bar / 4.000 psi
- Eccezionale scivolosità e resistenza all'abrasione
- Limitate espansione volumetrica e perdite di carico

Main features

- Top-class flexibility
- Working pressure from 200 bar / 3.000 psi to 275 bar / 4.000 psi
- Super sliding and abrasion resistant
- Low volumetric expansion and pressure drop

Caratteristiche tecniche

Caratteristiche tecnico-costruttive:

Anima interna in compound termoplastico, rinforzo con 2 o più trecce in fibra tessile ad alta tenacità e rivestimento esterno in poliuretano anti-abrasione, stabilizzato ai raggi UV e resistente all'idrolisi, per applicazioni all'esterno in ambienti particolarmente umidi.

Applicazioni:

Le tubazioni della serie JC7 PRO sono state sviluppate per passaggio acqua nel settore della pulizia ad alta pressione.

Temperature di utilizzo:

da -40°C a +55°C (-40°F a +131°F)

Pressioni d'esercizio:

rapporto di sicurezza 1:2.5

Lunghezza pezzature:

disponibili secondo necessità, fino a 350 metri.

Technical Features

Technical-constructive features:

Inner core in thermoplastic compound, 2 or more reinforcement braids in high tenacity textile fibers and exterior covering in antiabrasion polyurethane, stabilized to UV rays and resistant to hydrolysis, for outdoor applications in environments having high humidity levels.

Applications:

The JC7 PRO Series hoses have been created for water applications in the high pressure cleaning field.

Working temperature:

from -40°C to +55°C (-40°F to 131°F)

Working pressure:

Safety ratio 1:2.5

Reels length:

Available upon request, up to 350mts.

Scheda tecnica - Data Sheet



CODE	inch	-dash	mm	DN	inch	mm	bar	psi	mm	inch	g/m	lbs/ft	FERRULE CODE
JC767109FL	1/2"	-8	13.0	12	0.882	22.4	275	3990	65	2.56	290	0.195	BP12JC7
JC787109FL	3/4"	-12	19.2	19	1.173	29.8	210	3045	100	3.94	405	0.272	BP34JC7



Lavaggio e pulizia alta pressione

JC7U-3000 AMERICAN STANDARD



Caratteristiche principali

- Pressione di lavoro 207 bar / 3.000 psi
- Elevata compattezza
- Eccezionale resistenza a kinking, torsione e schiacciamento
- Compatibilità con raccordi ed accessori in uso sul mercato

Main features

- Working pressure from 207 bar / 3.000 psi
- Compact and consistent solution
- High kinking, torsion and flattening resistance
- Compatibility with fittings and accessories standard on market

Caratteristiche tecniche

- **Caratteristiche tecnico-costruttive:**
Anima interna compound termoplastico, rinforzo con 2 o più trecce in fibra tessile ad alta tenacità e rivestimento esterno in poliuretano antiabrasione, microforato, stabilizzato ai raggi UV e resistente all'idrolisi, per applicazioni all'esterno, in ambienti particolarmente umidi e salini.
- **Applicazioni:**
Le tubazioni della serie JC7U sono state create per passaggio acqua nel settore della pulizia ad alta pressione.
- **Temperature di utilizzo:**
da -40°C a +55°C (-40°F a +131°F)
- **Pressioni d'esercizio:**
rapporto di sicurezza 1:2.5
- **Valore max. di vuoto:**
0.93 bar; 700 mmHg.
- **Variatione longitudinale:**
+/- 1.5%
- **Lunghezza pezzature:**
disponibili secondo necessità, fino a 350 metri.

Technical Features

- **Technical-constructive features:**
Inner core in thermoplastic compound, 2 or more reinforcement braids in high tenacity textile fibers and outer covering in antiabrasion polyurethane, pin-pricked, stabilized to UV rays and resistant to hydrolysis for outdoor applications, in environments having high humidity and saline levels.
- **Applications:**
The JC7U Series hoses have been created for water applications in the high pressure cleaning field.
- **Working temperature:**
from -40°C to +55°C (-40°F to 131°F)
- **Working pressure:**
Safety ratio 1:2.5
- **Max. vacuum value:**
0.93 absolute bar; 700 mmHg.
- **Length variation:**
+/- 1.5%
- **Reels length:**
Available upon request, up to 350mts.

Scheda tecnica - Data Sheet



CODE	inch	-dash	mm	DN	inch	mm	bar	psi	bar	psi	mm	inch	g/m	lbs/ft	FERRULE CODE
JC7U67102	1/2"	-8	12.7	13	0.799	20.3	207	3000	517	7500	140	5.512	296	0.199	BP12JC7
JC7U77102	5/8"	-10	16.0	16	0.961	24.4	207	3000	517	7500	140	5.512	379	0.255	BP34R7
JC7U87102	3/4"	-12	19.2	19	1.165	29.6	207	3000	517	7500	170	6.693	517	0.347	BP34JC7
JC7U97102	1"	-16	25.6	25	1.468	37.3	207	3000	517	7500	190	7.480	780	0.524	BP1JC7S

JC8-3600



Caratteristiche principali

- Pressione di lavoro 250 bar / 3.600 psi
- Eccezionale scivolosità e resistenza all'abrasione
- Limitate espansione volumetrica e perdite di carico
- Elevata velocità di avanzamento e galleggiamento

Main features

- Working pressure 250 bar / 3.600 psi
- Super sliding and abrasion resistant
- Low volumetric expansion and pressure drop
- High operating speed and floatation

Caratteristiche tecniche

• Caratteristiche tecnico-costruttive:

Anima interna in polimero termoplastico, rinforzo con 2 o più trecce in fibra tessile ad alta tenacità e rivestimento esterno in poliuretano antiabrasione, microforato, stabilizzato ai raggi UV e resistente all'idrolisi, per applicazioni all'esterno, in ambienti particolarmente umidi e salini.

• Applicazioni:

Le tubazioni della serie JC8 sono state create per passaggio acqua nel settore della pulizia ad alta pressione.

• Temperature di utilizzo:

da -40°C a +55°C (-40°F a +131°F)

• Pressioni d'esercizio:

rapporto di sicurezza 1:2.5

• Lunghezza pezzature:

disponibili secondo necessità, fino a 350 metri.

Technical Features

• Technical-constructive features:

Inner core in thermoplastic polymer, 2 or more reinforcement braids in high tenacity textile fibers and outside covering in antiabrasion polyurethane, pinpricked, stabilized to UV rays and resistant to hydrolysis for outdoor applications, in environments having high humidity and saline levels.

• Applications:

The JC8 Series hoses have been created for water applications in the high pressure cleaning field.

• Working temperature:

from -40°C to +55°C (-40°F to 131°F)

• Working pressure:

Safety ratio 1:2.5

• Reels length:

Available upon request, up to 350mts.

Scheda tecnica - Data Sheet



CODE	inch	-dash	mm	DN	inch	mm	bar	psi	mm	inch	g/m	lbs/ft	FERRULE CODE
JC867105	1/2"	-8	13.0	12	0.882	22.4	345	5000	100	3.94	292	0.196	BP12JC7
JC887105	3/4"	-12	19.2	19	1.173	29.8	250	3625	120	4.72	460	0.309	BP34JC7
JC897105	1"	-16	25.6	25	1.469	37.3	250	3625	150	5.91	643	0.432	BP1JC7
JC8107105	1" 1/4	-20	32.0	32	1.811	46.0	250	3625	235	9.25	985	0.662	BP114MTKHM

JC8X-3600 EXTRA TOUGH



Caratteristiche principali

- Pressione costante 250 bar / 3.600 psi
- Eccezionale resistenza al kinking e torsione
- Limitate espansione volumetrica e perdite di carico
- Soluzione ideale per pulizia reti allevamenti ittici

Main features

- Constant pressure 250 bar / 3.600 psi
- Ultra kinking and torsion resistance
- Low volumetric expansion and pressure losses
- Ultimate solution for fish farming net cleaning

Caratteristiche tecniche

- **Caratteristiche tecnico-costruttive:**
Anima interna in compound poliolefinico, rinforzo con 2 o più trecce in fibra tessile ad alta tenacità e rivestimento esterno microforato in poliuretano water-proof, stabilizzato ai raggi UV e resistente all'idrolisi, per applicazioni all'esterno, in ambienti particolarmente umidi e salini.
- **Applicazioni:**
Le tubazioni della serie JC8X sono state progettate per applicazioni di pulizia delle reti da pesca.
- **Temperature di utilizzo:**
da -40°C a +55°C (Da -40°F a +131°F)
- **Pressioni d'esercizio:**
rapporto di sicurezza 1:2.5
- **Colore:**
Rosso, a richiesta altri colori.
- **Lunghezza pezzature:**
disponibili secondo necessità, fino a 350 metri.

Technical Features

- **Technical-constructive features:**
Inner core in polyolefin compound, 2 or more reinforcement braids in high tenacity textile fibers and outside covering in pinpricked water-proof polyurethane, stabilized to UV rays and resistant to hydrolysis for outdoor applications, in environments having high humidity and saline levels.
- **Applications:**
The JC8X Series hoses have been designed for fish farming net cleaning applications.
- **Working temperature:**
from -40°C to +55°C (From -40°F to +131°F)
- **Working pressure:**
Safety ratio 1:2.5
- **Colour:**
Red, others colors available upon request.
- **Reels length:**
Available upon request, up to 350mts.

Scheda tecnica - Data Sheet



CODE	inch	-dash	mm	DN	inch	mm	bar	psi	bar	psi	mm	inch	g/m	lbs/ft	FERRULE CODE
JC8X87105	3/4"	-12	19.4	19	1.275	32.4	250	3625	625	9065	120	4.724	585	0.3931	BPI34MTKM
JC8X97105	1"	-16	25.6	25	1.582	40.2	250	3625	625	9065	150	5.905	800	0.5375	BPI1MTKM
JC8X107105	1" 1/4	-20	32.0	32	1.898	48.2	250	3625	625	9065	235	9.251	1063	0.7143	BPI114R2T

JC8M-5800



Caratteristiche principali

- Lavaggio industriale ad altissima pressione 400 bar / 5800 psi
- Eccezionale scivolosità e resistenza all'abrasione
- Elevata velocità di avanzamento e minima espansione volumetrica

Main features

- Very high pressure industrial cleaning 400 bar / 5800 psi
- Super sliding and abrasion resistant
- High operating speed and minimum volumetric expansion

Caratteristiche tecniche

• Caratteristiche tecnico-costruttive:

Anima interna in poliammide, rinforzo con 2 o più trecce in fibra tessile ad alta tenacità e rivestimento esterno microforato in poliuretano antiabrasione, stabilizzato ai raggi UV e resistente all'idrolisi, per applicazioni all'esterno, in ambienti particolarmente umidi e salini.

• Applicazioni:

Le tubazioni della serie JC8M sono state create per passaggio acqua nel settore della pulizia ad alta pressione.

• Temperature di utilizzo:

da -40°C a +55°C (Da -40°F a +131°F)

• Pressioni d'esercizio:

rapporto di sicurezza 1:2.5

• Colore:

Rosso, a richiesta altri colori.

• Lunghezza pezzature:

disponibili secondo necessità, fino a 350 metri.

Technical Features

• Technical-constructive features:

Inner core in polyamide, 2 or more reinforcement braids in high tenacity textile fibers and outside covering in pin-pricked antiabrasion polyurethane, stabilized to UV rays and resistant to hydrolysis for outdoor applications, in environments having high humidity and saline levels.

• Applications:

The JC8M Series hoses have been created for water applications in the high pressure cleaning field.

• Working temperature:

from -40°C to +55°C (From -40°F to +131°F)

• Working pressure:

Safety ratio 1:2.5

• Colour:

Red, others colors available upon request.

• Reels length:

Available upon request, up to 350mts.

Scheda tecnica - Data Sheet



CODE	inch	-dash	mm	DN	inch	mm	bar	psi	bar	psi	mm	inch	g/m	lbs/ft	FERRULE CODE
JC8M87105	3/4"	-12	19.2	19	1.181	30.0	400	5801	1000	14504	185	7.283	442	0.2970	BP34MTKM
JC8M97105	1"	-16	25.8	25	1.555	39.5	400	5801	1000	14504	250	9.842	735	0.4939	BP1MTKM
JC8M107105	1" 1/4	-20	32.0	32	1.878	47.7	400	5801	1000	14504	400	15.75	1054	0.7082	BP114R2T

JCL-5000



Caratteristiche principali

- Serie isobarica -WP 345bar / 5,000psi
- Per la pulizia delle canalizzazioni secondarie e domestiche o di supporto alla video ispezione
- Eccezionale scivolosità e resistenza all'abrasione
- Flessibilità e resistenza al kinking

Main features

- Isobaric series - WP 345bar / 5,000psi
- For high pressure cleaning of lateral and domestic lines or for video-inspection cleaning support
- Super sliding and abrasion resistant
- Flexible and kinking resistant

Caratteristiche tecniche

- **Caratteristiche tecnico-costruttive:**
Anima interna in polimero termoplastico, rinforzo con trecce in filato tessile ad alta tenacità e rivestimento esterno in poliuretano antiabrasione, stabilizzato ai raggi UV e resistente all'idrolisi, per applicazioni all'esterno, in ambienti particolarmente umidi.
- **Applicazioni:**
Le tubazioni della serie JCL sono state create per passaggio acqua ad alta pressione per la pulizia e lo spurgo fogne secondarie in ambito industriale e domestico.
- **Pressioni d'esercizio:**
Rapporto di sicurezza 1:2.5
- **Temperature di utilizzo:**
da -40°C a +70°C (-40°F a +158°F).
- **Variazione longitudinale:**
da -0% a +3%
- **Lunghezza pezzature:**
disponibili secondo necessità, fino a 350 metri.

Technical Features

- **Technical-constructive features:**
Inner core in thermoplastic polymer, reinforcement in high tensile fiber braids and outside covering in antiabrasion polyurethane, stabilized to UV rays and resistant to hydrolysis for outdoor applications, in environments having high humidity levels.
- **Applications:**
the JCL Series hoses have been developed for high pressure water jetting applications for cleaning and purging of industrial and domestic lateral sewage lines.
- **Working pressure:**
Safety ratio 1:2.5
- **Working temperature:**
from -40° to +70°C (-40°F a +158°F).
- **Length variation:**
-0% to +3%
- **Reels length:**
Available upon request, up to 350mts.

Scheda tecnica - Data Sheet



CODE	inch	-dash	mm	DN	inch	mm	bar	psi	mm	inch	g/m	lbs/ft	FERRULE CODE
JCL17100	1/8"	-2	3.5	3	0.295	7.5	345	5000	25	0.98	41	0.028	BP180L5
JCL27100	3/16"	-3	4.8	5	0.413	10.5	345	5000	30	1.18	69	0.046	BP316R7
JCL37100	1/4"	-4	6.4	6	0.480	12.2	345	5000	50	1.97	87	0.058	BP14MT1
JCL57100	3/8"	-6	9.7	10	0.661	16.8	345	5000	75	2.95	156	0.105	BP38R7V

JET WASH

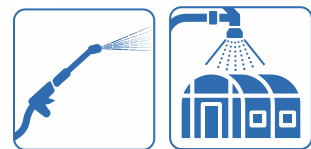
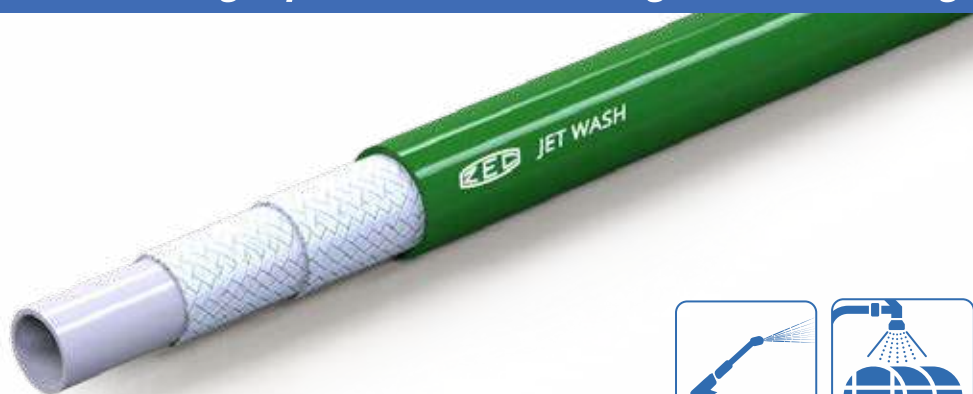

Caratteristiche principali

- Eccezionale scivolosità e resistenza all'abrasione
- Flessibile e resistente al kinking
- Per lavaggio industriale e serre a media pressione in applicazioni di orticoltura

Main features

- *Super sliding and abrasion resistant*
- *Flexible and kinking resistant*
- *For mid-pressure industrial and greenhouse cleaning in horticulture applications*

Caratteristiche tecniche

• Caratteristiche tecnico-costruttive:

Anima interna in polietilene, rinforzo con treccia in fibra ad alta resistenza e rivestimento esterno in poliuretano verde antiabrasione microperforato, stabilizzato ai raggi UV e resistente a microorganismi ed all'idrolisi, per applicazioni all'esterno, in ambienti particolarmente umidi.

• Applicazioni:

I tubi della serie Jet Wash sono stati sviluppati per il trasporto di acqua e detersivi per il lavaggio industriale e di serre a media pressione in applicazioni di orticoltura.

• Pressioni d'esercizio:

Rapporto di sicurezza 1:2.5

• Temperature di utilizzo:

da -40°C a +55°C (-40°F a +131°F).

• Variazione longitudinale:

+/- 1.5%

• Lunghezza pezzature:

disponibili secondo necessità, fino a 350 metri.

Technical Features

• Technical-constructive features:

Inner core in polyethylene, reinforcement in high tensile fiber braid and chemically bonded outside pin-pricked covering in anti-abrasion green polyurethane, stabilized to UV light, and resistant to microorganisms and hydrolysis for outdoor applications, in environments having high humidity levels.

• Applications:

The JW series hoses have been developed for conveying water and detergents in mid-pressure industrial and greenhouse cleaning in horticulture applications.

• Working pressure:

Safety ratio 1:2.5

• Working temperature:

from -40° to +55°C (-40°F a +131°F).

• Length variation:

+/- 1.5%

• Reels length:

Available upon request, up to 350mts.

Scheda tecnica - Data Sheet



CODE	inch	-dash	mm	DN	inch	mm	bar	psi	mm	inch	g/m	lbs/ft	FERRULE CODE
JW57109AR	3/8"	-6	9.7	10	0.594	15.1	100	1450	50	1.969	111	0.075	BP38R7V
JW67109AR	1/2"	-8	12.5	12	0.728	18.5	100	1450	80	3.150	150	0.101	BP12R7V
JW77109AR	5/8"	-10	16.0	16	0.906	23.0	100	1450	120	4.724	223	0.150	BP58R7V
JW87109AR	3/4"	-12	19.2	19	1.047	26.6	100	1450	180	7.087	272	0.183	BP34R7V

MT1E WATERPROOF

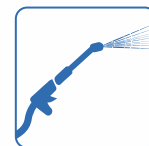

Caratteristiche principali

- Pressioni di lavoro fino a 500 bar / 7.200 psi
- Elevata resistenza allo schiacciamento e flessibilità
- Espansione volumetrica ridotta
- Ideale per applicazioni idropulitrici professionali

Main features

- Working pressure up to 500 bar / 7.200 psi
- Very flexible and crushing resistant
- Low volumetric expansion
- Ideal solution for professional pressure washers

Caratteristiche tecniche

Caratteristiche tecnico-costruttive:

Anima interna in polietilene, rinforzo con una treccia in acciaio ad alta resistenza, ricopertura esterna in poliuretano antiabrasione resistente all'idrolisi, stabilizzato per applicazioni all'esterno, in ambienti particolarmente umidi.

Applicazioni:

Le tubazioni della serie MT1E WATER-PROOF COVER sono state create per passaggio acqua nel settore della pulizia ad alta pressione.

Pressioni d'esercizio:

Rapporto di sicurezza 1:2.5

Temperature di utilizzo:

da -20°C a +60°C, da -4°F a +140°F.

Technical Features

Technical-constructive features:

Inner core in polyethylene, reinforcement in high tensile steel braid and exterior covering in antiabrasion polyurethane resistant to hydrolysis and micro-organisms, suitable for outdoor applications in environments having high humidity and saline levels.

Applications:

MT1E WATER-PROOF COVER hose series have been created for water applications in the high pressure cleaning sector.

Working pressure:

Safety ratio 1:2.5

Working temperature:

from -20°C to +60°C, from -4°F to +140°F.

Scheda tecnica - Data Sheet



CODE	inch	-dash	mm	DN	inch	mm	bar	psi	mm	inch	g/m	lbs/ft	FERRULE CODE
MT127000E	3/16"	-3	4.8	5	0.394	10.0	560	8122	30	1.18	126	0.085	BP316R7
MT137000E	1/4"	-4	6.4	6	0.469	11.9	480	6962	40	1.57	166	0.112	BP14MT1
MT147000E	5/16"	-5	8.0	8	0.551	14.0	384	5569	50	1.97	205	0.138	BP516R7V
MT157000E	3/8"	-6	9.7	10	0.630	16.0	360	5221	60	2.36	246	0.165	BP38R1TV
MT167000E	1/2"	-8	13.0	12	0.756	19.2	304	4409	75	2.95	314	0.211	BP12R2TV



ACCESSORI E SERVIZI per pulizia delle canalizzazioni fognarie

ACCESSORIES AND SERVICES for Sewer jetting applications

GUIDA TUBOLARE PROTEGGI TUBO IN POLIETILENE POLYETHYLENE HOSE PROTECTION GUIDE



Caratteristiche:

- Facilita l'operazione di inserimento ed estrazione del tubo spurgo dalla fognatura
- Elimina problematiche di danni da abrasione in fase di ingresso nella canalizzazione
- Aumenta l'efficienza operativa e la durata di vita del tubo

Specifiche tecniche:

- Estrema leggerezza
- Super flessibile
- Resistente all'usura ed agli urti
- Resistente al freddo
- Facile da maneggiare

Applicazioni

Protezione per tubo spurgo

Temperatura di esercizio:

Da -40°C a +60°C (Da -40°F a +140°F)

Caratteristiche:

- Facilitates the insertion and extraction of the hose from the sewer
- Eliminates problems of abrasion damage during entry into the sewer
- Increases the operating efficiency and hose lifetime

Specifiche tecniche:

- Extreme lightness
- Super flexible
- Crush and abrasion proof
- Cold weather resistant
- Easy to handle

Applicazioni

Sewer hose protection

Temperatura di esercizio:

From -40°C to +60°C (From -40°F to +140°F)

Codice / Code	Ø Interno ID (mm)	Min.Raggio Curv. MBR (mm)	Peso / Weight (g/m)	Lunghezza / Length (m)
PCPH51100	51	89	1071	1
PCPH76100	76	165	2024	1

SERVIZI / SERVICES

ZEC dispone di una vasta gamma di raccordi a pressare in acciaio al carbonio ed AISI316.

Su tutta la gamma JC offriamo su richiesta il servizio di raccordatura ed avvolgimento su bobina.

ZEC offers a wide range of crimped fittings in carbon steel and AISI316.

On the entire JC range, we offer the crimping and winding on reels service, on request.

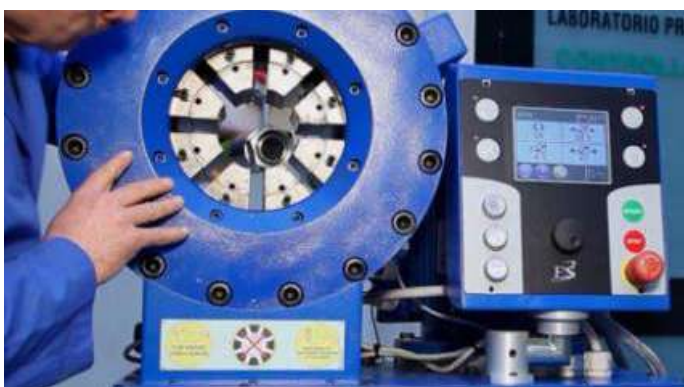

Raccordi recuperabili JC7 / JC7 reusable fittings

BOCCOLA RECUPERABILE REUSABLE FERRULE

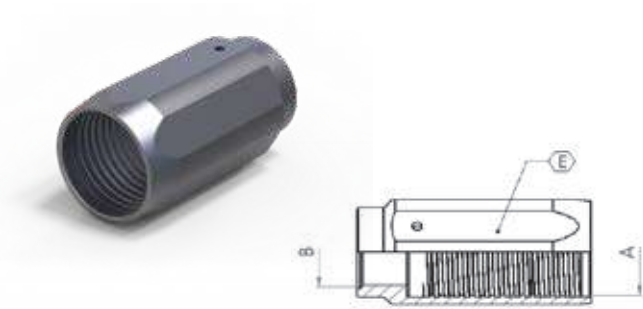

Codice / Part Nr.	Tubo / Hose	A	B	E
BJC7R12	1/2"	21.6	5/8" UNF	27
BJC7R34	3/4"	29.6	M24x1.5	36
BJC7R1	1"	36.9	M31.5x1.5	46
BJC7R114	1" 1/4	45.0	M40x1.5	55

MASCHIO BSPP SV. 60° RECUPERABILE REUSABLE MALE BSPP 60° CONE

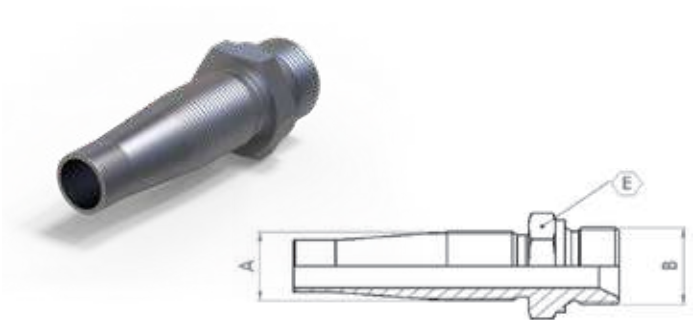

Codice / Part Nr.	Tubo / Hose	A	B	E
RJC7RMD12BP12	1/2"	5/8" UNF	1/2"	27
RJC7RMD34BP34	3/4"	M24x1.5	3/4"	32
RJC7RMD1BP1	1"	M31.5x1.5	1"	41
RJC7RMD114BP114	1" 1/4	M40x1.5	1" 1/4	50

Materiale: acciaio AVP zincato.

In caso di utilizzo di raccordi recuperabili per JC7 la pressione di lavoro **non deve superare il 90% della pressione massima d'esercizio** dichiarata in scheda tecnica.

Material: galvanized carbon steel.

When using reusable JC7 fittings the working pressure **must not exceed 90% of the max. working pressure** declared in the technical data sheet.

Giunzioni a pressare per tubi JC5 / JC7 da 1/4" a 1"1/2 Joint fittings for hoses JC5 / JC7 from 1/4" to 1"1/2

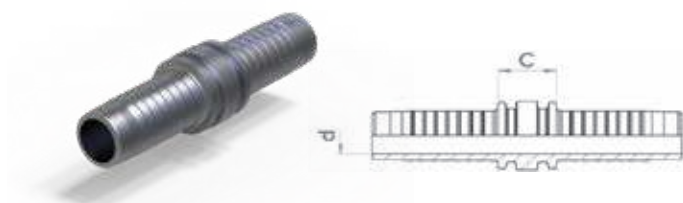

Codice / Part Nr.	Tubo / Hose	d	C
RPG1414	1/4"	4.0	17.0
RPG3838	3/8"	7.0	17.0
RPG1212	1/2"	9.5	18.0
RPG5858	5/8"	12.0	18.0
RPG3434	3/4"	15.0	19.0
RPG11	1"	20.0	21.0
RPG114114	1" 1/4	26.0	24.0
RPG112112	1" 1/2	32.0	24.0

Raccordi One-Piece per tubi JC5 - JC5U - JC7 - JC7U One-Piece fittings for JC5 - JC5U - JC7 - JC7U hoses

FEMMINA GIREVOLE BSPP ONE-PIECE
FEMALE SWIVEL BSPP ONE-PIECE

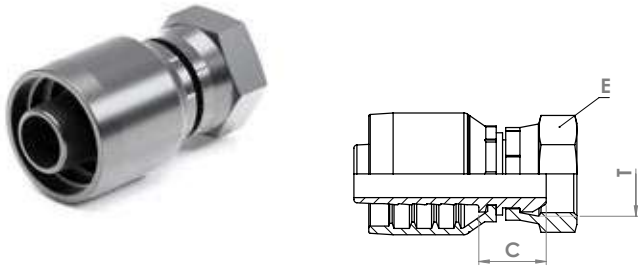

MASCHIO BSPP ONE-PIECE
MALE BSPP ONE-PIECE

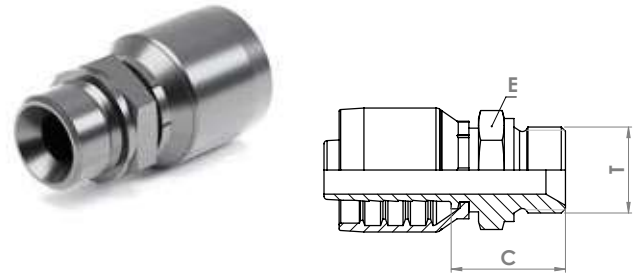

Codice / Part Nr.	Tubo / Hose	T	C	E
RUPFD12BP12H	1/2"	1/2"-14	23	27
RUPFD34BP34H	3/4"	3/4"-14	27	32
RUPFD1BP1H	1"	1"-11	30	41
RUPFD114BP1H	1"	1"1/4-11	35	50
RUPFD114BP114H	1" 1/4	1" 1/4-11	34	50

Codice / Part Nr.	Tubo / Hose	T	C	E
RUPMD12BP12H	1/2"	1/2"-14	33	27
RUPMD34BP34H	3/4"	3/4"-14	37	32
RUPMD1BP1H	1"	1"-11	43	41
RUPMD114BP1H	1"	1"1/4-11	46	50
RUPMD114BP114H	1" 1/4	1" 1/4-11	47	50

Giunzione tubo One-Piece Hose Joint One-Piece

MASCHIO NPT ONE-PIECE
MALE NPT ONE-PIECE

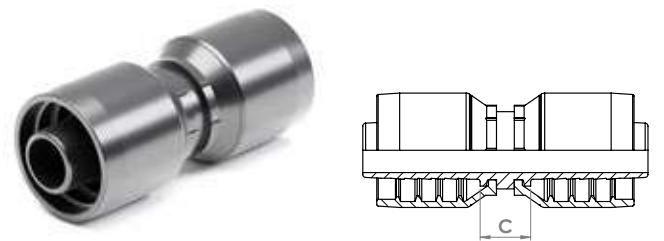
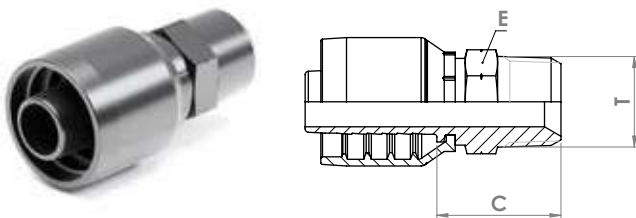

Codice / Part Nr.	Tubo / Hose	T	C	E
RUPMD12NC12H	1/2"	1/2"-14	35	22
RUPMD34NC34H	3/4"	3/4"-14	38	27
RUPMD1NC1H	1"	1"-11	47	35
RUPMD114NC1H	1"	1"1/4-11	51	46
RUPMD114NC114H	1" 1/4	1" 1/4-11	52	46

Codice / Part Nr.	Tubo / Hose	C
RUPG1212H	1/2"	15
RUPG3434H	3/4"	18
RUPG11H	1"	21
RUPG114114H	1" 1/4	22



Istruzioni di sicurezza e raccomandazioni operative Safety instructions & recommended practices

Installazione e messa in servizio / Mounting & Operating



1
Do not force the hose in proximity to fitting during connecting operation to truck.
Non forzare il tubo in prossimità del raccordo durante la prima installazione e durante il servizio.

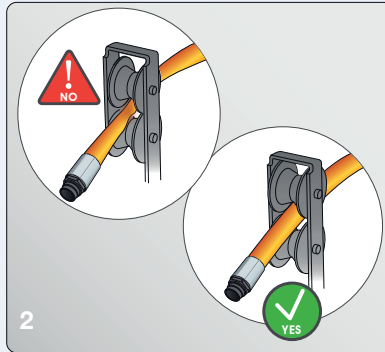

2
Use suitable truck hose reels on truck and proper roller guides, not over-squeezing the hose excessively.
Assicurarsi di utilizzare aspo adeguato e che le guide del tubo sul camion siano tarate per non schiacciare eccessivamente il tubo.

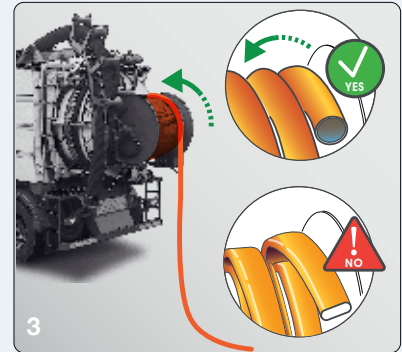

3
Roll-up the hose only under pressure.
Riavvolgere il tubo solamente in pressione.

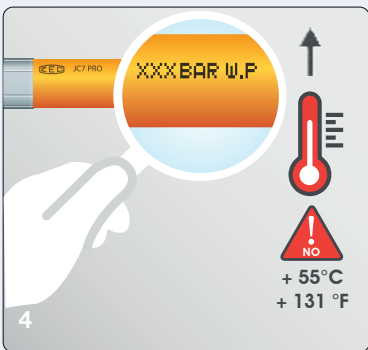

4
Never exceeds maximum WP reported onto hose layline, neither maximum working temperature: +55°C / +131°F.
Non superare la pressione di lavoro riportata sul tubo, né la temperatura di lavoro di +55°C.

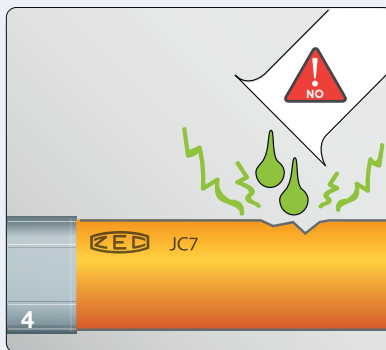

4
Avoid contact with any aggressive fluid.
Evitare qualsiasi contatto con fluidi aggressivi.



6
Do not over-bend (kink) hose anytime; this can cause «kinking» effect, reducing hose performances and safety.
Evitare di piegare eccessivamente il tubo; questo può causare l'effetto "kinking" mettendo a repentaglio la sicurezza.

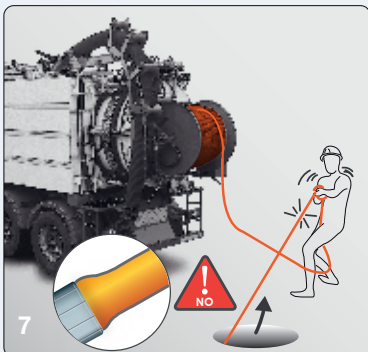

7
Do not over pull the hose neither manually nor using truck in case nozzle got stuck.
In caso di blocco dell'ugello durante il servizio, non tirare il tubo manualmente o con il camion.

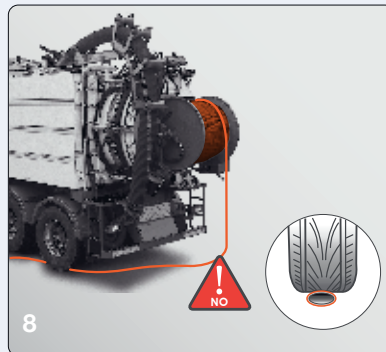

8
Do not «squeeze» the hose with truck or other heavy equipments.
Evitare di schiacciare il tubo con il camion o con altri oggetti pesanti.

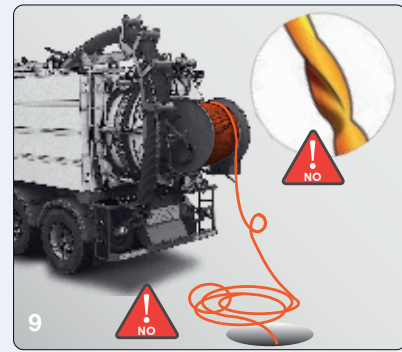

9
Avoid hose twisting and loops formation during operation.
Evitare di torcere o attorcigliare il tubo durante il servizio.

Riparazione di un tubo danneggiato / Hose assembly repair

1. I tubi sono stati studiati per essere utilizzati assieme a raccordi speciali montati con l'utilizzo di adeguata attrezzatura di assemblaggio realizzata da personale specializzato.
2. Non si consiglia l'uso di raccordi alternativi a ZEC, a meno di non avere la possibilità di testare adeguatamente il prodotto prima dell'uso.
3. Per le operazioni di riparazione si consiglia di seguire le "istruzioni di raccordatura" pubblicate sulla pagina web: www.zecspa.com/en/reserved-area
4. Operazioni di ri-raccordatura sono tollerate, sempre quando la parte di tubo interessata sia integra e non eccessivamente consumata.

1. Hoses are designed to be used with specific fittings, but also proper crimping/swaging equipments and by qualified professionals.
2. The use of different fitting brands is not recommended, unless hose can be properly tested again before use;
3. For repairing operations please follow the «crimping instructions» published on our web site: www.zecspa.com/en/reserved-area
4. Re-crimping operations are tolerated, whenever the part to be crimped is intact and not over used.

Raccomandazioni di lavoro / Working recommendations

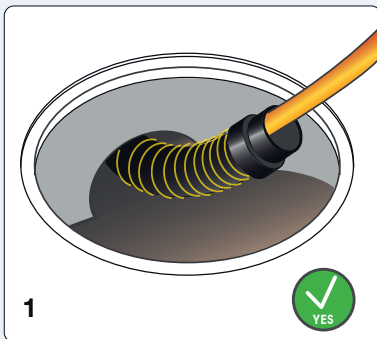

Corner protection.
Guida tubolare proteggi spigolo.

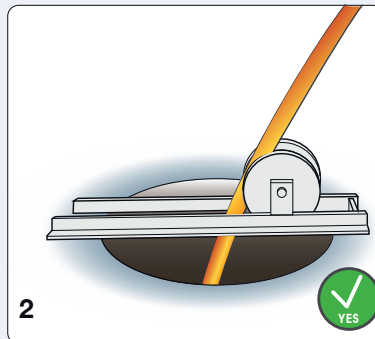

Roller guide.
Guida rotativa.

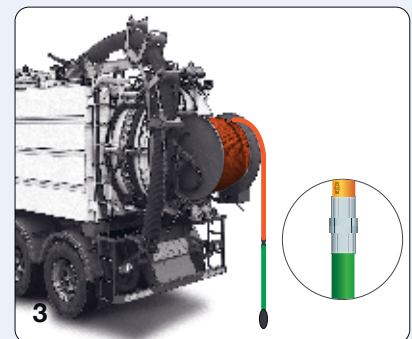

Rubber or thermoplastic "Leader Hose"; to facilitate the operation and to signal the nozzle return.
Tubo Leader di gomma o termoplastico che faciliti l'operazione di inserimento e segnali l'uscita dell'ugello durante il recupero del tubo.

We recommend the use of supporting tools to improve sewerage operation performance and hose lifetime!
Si raccomanda l'utilizzo di questi accessori per aumentare l'efficienza operativa e la durata di vita del tubo!



Sistemi di nebulizzazione

Misting Systems



PA12 HL MISTING



Caratteristiche principali

- Tubi in poliammide per alta pressione
- Standard per sistemi di nebulizzazione per uso industriale, agricolo e per sistemi di raffreddamento commerciale

Main features

- High pressure polyamide tubing
- Standard for misting systems for industrial and agricultural applications, but also for commercial cooling systems

Caratteristiche tecniche

- **Temperatura di esercizio:**
Da -40°C a +100°C.
Per fluidi a base acquosa temperatura di esercizio +70°C.
- **Picchi di temperatura:**
Max +125°C.
Se la durata o la frequenza dei picchi è rilevante, la durata di vita utile del tubo potrebbe essere ridotta.

Technical Features

- **Temperature range:**
From -40° to +100°C.
Working temperature of water-based fluids +70°C.
- **Temperature peaks:**
Max +125°C.
If the duration or frequency of the peaks is significant, the hose lifespan may be reduced.

Coefficiente di correzione della pressione di scoppio in funzione della temperatura

Pressure correction factor as function of temperature

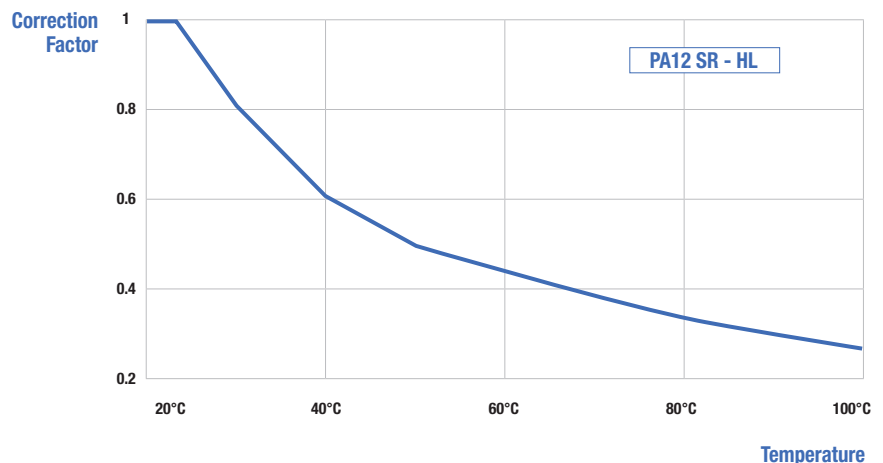

Scheda tecnica - Data Sheet



CODE	inch	mm	inch	mm	inch	mm	bar	mm	g/m	Colors	m
TA525*SR	0.098	2.50		5.00	0.049	1.25	93	32	14.9	N	100
TA6353*SR	0.118	3.00	1/4"	6.35	0.066	1.675	95	40	24.8	T-N	100
TA635385*SR	0.152	3.85	1/4"	6.35	0.049	1.25	68	45	20.2	N	100
TA9525*SR	0.197	5.00	3/8"	9.52	0.089	2.26	87	120	52	N	100
TA1277*SR	0.276	7.00	1/2"	12.70	0.112	2.85	87	120	89	N	50

■ T: Natural ■ N: Black

NB: nel codice compare un *, bisogna sostituirlo con la sigla del colore del tubo. Il tubo di colore NERO è indicato per applicazioni all'esterno.
NB: in the code there is an *, this must be replaced with the colour code of the tube. Black hoses/tubing are recommended for outdoor applications.

OL7-LT WATERPROOF COVER



Caratteristiche principali

- Tubi rinforzati per alte pressioni
- Elevata resistenza all'idrolisi ed ai raggi UV
- Standard per sistemi di nebulizzazione per uso industriale, agricolo e per sistemi di raffreddamento commerciale

Main Features

- High pressure thermoplastic solution
- High resistance to Hydrolysis and UV-rays
- Standard for misting systems for industrial and agricultural applications, but also for commercial cooling systems

Caratteristiche tecniche

• Caratteristiche tecnico-costruttive:

Anima interna in poliestere termoplastico, rinforzo in fibra di poliestere e rivestimento esterno in poliuretano antiabrasione stabilizzato ai raggi UV e resistente all'idrolisi e ai microrganismi, adatto per applicazioni all'esterno in ambienti particolarmente umidi e salini, microforato per passaggio aria e gas compatibili.

• Applicazioni:

Le tubazioni della serie OL7-LT sono state create per applicazioni oleodinamiche in ambienti MARINI ad alta pressione; questo tipo di tubazione offre inoltre una buona flessibilità alle basse temperature ed è particolarmente consigliato su macchine operatrici e carrelli elevatori, che operano alle basse temperature.

• Temperature di utilizzo:

Da -54°C a +100°C Da -65°F a +212°F.

Per aria, acqua e fluidi a base acquosa la temperatura massima di esercizio è +70°C (158°F).

Utilizzo a bassa temperatura limitato ad applicazioni statiche.

• Pressioni d'esercizio:

Rapporto di sicurezza 1:4

• Valore max. di vuoto:

0.93 bar; 700 mm Hg

Technical Features

• Technical-constructive features:

Inner core in thermoplastic polyester, reinforcement in polyester textile and exterior covering in antiabrasion polyurethane stabilized against UV rays and resistant to hydrolysis and micro-organisms, suitable for outdoor applications in environments having high humidity and saline levels, pinpricked for conduction of air and compatible gases.

• Applications:

Hoses of the OL7-LT Series have been created for high pressure hydraulic applications in MARINE environments; this type of hose offers good flexibility at low temperatures and is particularly recommended for operating machines and lift trucks, which work at low temperatures.

• Working temperatures:

From -54°C to +100°C From -65°F to +212°F.

Max. working temperature with air, water and water-based fluids is +70°C (158°F).

Use at low temperature only in static applications.

• Working pressure:

Safety ratio 1:4

• Vacuum rating:

0.93 bar; 700 mm Hg

Scheda tecnica - Data Sheet



CODE	inch	-dash	mm	DN	inch	mm	bar	psi	mm	inch	g/m	lbs/ft	FERRULE CODE
OL717100	1/8"	-2	3.5	3	0.335	8.5	230	3335	12	0.47	57	0.038	BP18R7
OL78947100	5/32"	-2.5	4.0	4	0.350	8.9	250	3625	25	0.98	58	0.039	BP532R7
OL727100	3/16"	-3	4.8	5	0.394	10.0	210	3045	30	1.18	73	0.049	BP316R7
OL737100	1/4"	-4	6.4	6	0.465	11.8	200	2900	35	1.38	90	0.060	BP14R7
OL747100	5/16"	-5	8.0	8	0.563	14.3	190	2755	45	1.77	128	0.086	BP516R7V
OL757100	3/8"	-6	9.7	10	0.630	16.0	175	2537	55	2.17	155	0.104	BP38R7V
OL767100	1/2"	-8	13.0	12	0.799	20.3	140	2030	75	2.95	219	0.147	BP12R7V
OL777100	5/8"	-10	16.0	16	0.925	23.5	105	1522	120	4.72	277	0.186	BP58R7V
OL787100	3/4"	-12	19.2	19	1.043	26.5	90	1305	145	5.71	330	0.222	BP34R7V
OL797100	1"	-16	25.6	25	1.322	33.6	70	1015	200	7.87	403	0.271	BP1R7V



Sistemi di nebulizzazione / *Misting Systems*



Acqua potabile / Alta temperatura
Potable Water Handling / High Temperature



PE-LD



Caratteristiche principali

- Tubi in polietilene a bassa densità
- Normativa FDA 21 CFR, Reg. UE 1935/2004, REG UE 10/2011

Main features

- Low density polyethylene tubing
- Compliant with FDA 21 CFR, Reg. EU 1395/2004, REG EU 10/2001

Caratteristiche tecniche

Il Polietilene è una materia plastica molto leggera, con un buon rapporto qualità/prezzo ed un'ottima resistenza chimica. Tubazione non stabilizzata ai raggi "UV". Per applicazioni all'esterno si consiglia tubo di colore nero.

- **Temperatura di esercizio:**
Da -60°C a +40°C.

- **Specifiche:**
Reg. CE 1935/2004, Reg. UE 10/2011.
D.M. 174 del 06/04/2004.
FDA 21 CFR 177.1520.

È responsabilità dell'utente finale verificare la Dichiarazione di Conformità alimentare aggiornata.

Technical Features

Polyethylene is a very light plastic material with a good quality-price ratio and excellent chemical resistance. Tubing not stabilized against "UV" rays. Black tubing is recommended for outdoor applications.

- **Temperature range:**
from -60°C to +40°C.

- **Specifications:**
Reg. EC 1935/2004, Reg. EU 10/2011.
D.M. 174 of 06/04/2004.
FDA 21 CFR 177.1520.

It is end user responsibility to check the updated Food Declaration of Conformity.

Coefficiente di correzione della pressione di scoppio in funzione della temperatura Pressure correction factor as function of temperature

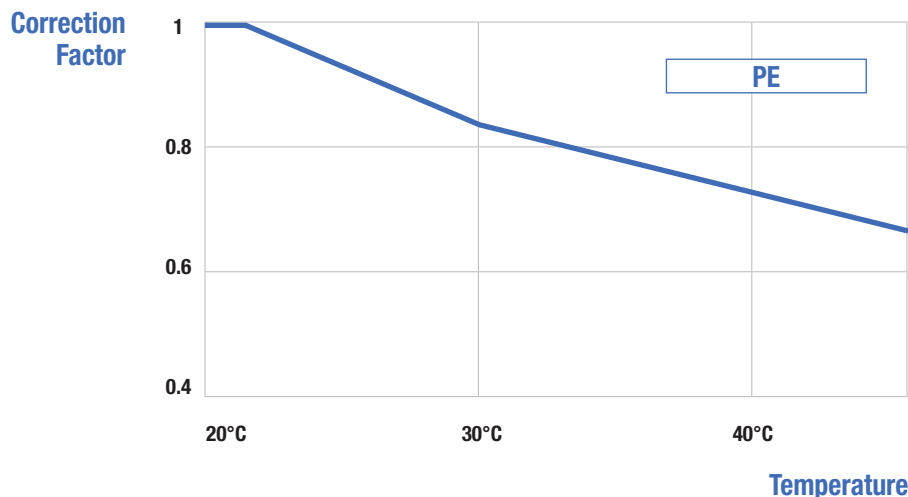

Scheda tecnica - Data Sheet



CODE	mm	mm	mm	bar	mm	g/m	Colors	m
PE42*	2	4	1	21	19	8.5	T-B-N-R-G	100
PE427*	2.7	4	0.65	13	30	6.2	T-B-N	100
PE425*	2.5	4	0.75	16	25	7.1	T-B-N	100
PE53*	3	5	1	17	23	11.3	T-B-N-R-G	100
PE63*	3	6	1.5	20	30	19.1	T-B-N-R-G	100
PE64*	4	6	1	13	32	14.1	T-B-N-R-G	100
PE85*	5	8	1.5	16	38	27.6	T-B-N	100
PE855*	5.5	8	1.25	13	40	23.8	T-B-N	100
PE86*	6	8	1	10	43	19.8	T-B-N-R-G	100
PE107*	7	10	1.5	11	60	36	T-B	100
PE108*	8	10	1	7	76	25.4	T-B-N-R-G	100
PE118*	8	11	1.5	11	80	40.3	T-B	100
PE128*	8	12	2	13	100	56.5	T-B	100
PE129*	9	12	1.5	10	100	44.5	T-B	100
PE1210*	10	12	1	7	122	31.1	T-B-N	100
PE1410*	10	14	2	11	130	67.8	T	100
PE1412*	12	14	1	5	150	36.7	T	100
PE1512*	12	15	1.5	8	147	57.2	T	100
PE15125*	12.5	15	1.25	5	160	48.6	T	100
PE1613*	13	16	1.5	5	200	61.5	T	100
PE1614*	14	16	1	4	300	42.4	T	100
PE1814*	14	18	2	8	200	90.4	T	100
PE2320*	20	23	1.5	4	300	91.1	T	100
PE1-4*	4.35	6.35	1	12	40	15.1	T-N	100
PE3-8*	6.36	9.54	1.59	11	60	35.7	T-N	100
PE1-2*	9.54	12.7	1.58	10	120	49.7	T-N	100

T: Natural
 B: Blue
 N: Black
 R: Red
 G: Yellow

NB: nel codice compare un *, bisogna sostituirlo con la sigla del colore del tubo.
 NB: in the code there is an *, this must be replaced with the colour code of the tube.

PTFE



Caratteristiche principali

- Pressione da 3 a 56 bar
- Normativa FDA 21 CFR, Reg. UE 1935/2004, Reg. UE 10/2011
- Temperatura di utilizzo da -60°C a +260°C

Main features

- Pressure from 3 to 56 bar
- Compliant with FDA 21 CFR, Reg. EU 1935/2004, Reg. EU 10/2011
- Working temperature from -60°C to + 260°C

Caratteristiche tecniche

I tubi in fluoropolimero PTFE hanno un range di temperature di utilizzo molto ampio e godono inoltre di un eccezionale resistenza chimica. Il PTFE non risente inoltre di fenomeni di migrazione di sostanze all'interno del fluido. Sono quindi ideali per tutte le applicazioni alimentari con fluidi sia a bassa sia ad alta temperatura. Queste tubazioni non dissipano le cariche elettrostatiche in presenza di fluidi non conduttivi.

- **Temperature di utilizzo:**
da -60°C a +260°C (da -76°F a +500°F)
- **Specifiche:**
Reg. UE 1935/2004, Reg. UE 10/2011.
FDA 21 CFR 177.1550.

È responsabilità dell'utente finale verificare la Dichiarazione di Conformità alimentare aggiornata.

Technical Features

PTFE fluoropolymer tubing have a broad range of operating temperatures and feature excellent chemical resistance. Moreover, since PTFE is not affected by leaching phenomena, these tubing are suitable for all food applications with fluids at low and temperatures. These tubing do not dissipate electrostatic charges when conveying non-conductive fluids.

- **Temperature range:**
from -60°C to +260°C (from -76°F to +500°F)
- **Specifications:**
Reg. EU 1935/2004, Reg. EU 10/2011.
FDA 21 CFR 177.1550.

It is end user responsibility to check the updated Food Declaration of Conformity.

Coefficiente di correzione della pressione di scoppio in funzione della temperatura Pressure correction factor as function of temperature

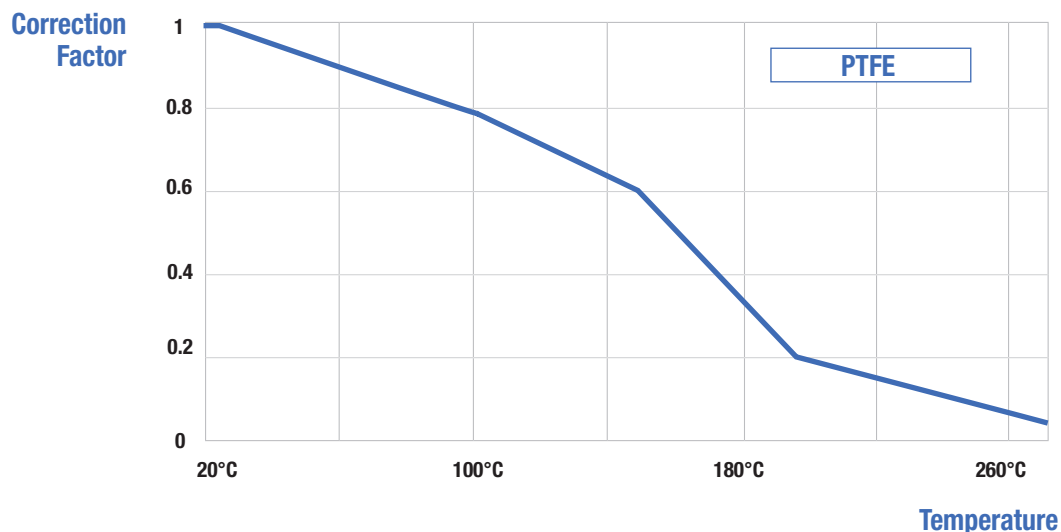

Scheda tecnica - Data Sheet



CODE	mm	mm	mm	bar	mm	Colors	g/m
PTFE31*	1	3	1.0	56	15	T-B-R-N	13.5
PTFE42*	2	4	1.0	27	20	T-B-R-N	22
PTFE43*	3	4	0.5	10	25	T-B-R-N	13
PTFE53*	3	5	1.0	22	25	T-B-R-N	29
PTFE63*	3	6	1.5	30	25	T-B-R-N	49
PTFE64*	4	6	1.0	18	30	T-B-R-N	37
PTFE85*	5	8	1.5	20	35	T-B-R-N	71
PTFE86*	6	8	1.0	14	40	T-B-R-N	51
PTFE107*	7	10	1.5	16	50	T-B-R-N	93
PTFE108*	8	10	1.0	12	60	T-B-R-N	66
PTFE129*	9	12	1.5	13	70	T-B-R-N	113
PTFE1210*	10	12	1.0	10	90	T-B-R-N	80
PTFE1412*	12	14	1.0	8	110	T-B-R-N	95
PTFE15125*	12.5	15	1.25	9	130	T-B-R-N	120
PTFE1513*	13	15	1.0	8	180	T-B-R-N	102
PTFE1614*	14	16	1.0	7	250	T-B-R-N	109
PTFE1815*	15	18	1.5	8	320	T-B-R-N	167
PTFE2220*	20	22	1.0	3	700	T-B-R-N	152

T: Natural
 B: Blue
 R: Red
 N: Black

NB: nel codice compare un *, bisogna sostituirlo con la sigla del colore del tubo.

NB: in the code there is an *, this must be replaced with the colour code of the tube.

FEP



Caratteristiche principali

- Alta cristallinità e trasparenza
- Pressione da 8 a 40 bar
- Normativa FDA 21 CFR, Reg. UE 1935/2004, Reg. UE 10/2011

Main features

- High crystallinity and transparency
- Pressure from 8 to 40 bar
- Compliant with FDA 21 CFR, Reg. EU 1935/2004, Reg. EU 10/2011

Caratteristiche tecniche

Il FEP è un copolimero del tetrafluoroetilene e del esafluoropropilene.

I tubi termoplastici prodotti con questo materiale hanno caratteristiche fisico meccaniche che si avvicinano a quelli in PTFE, ma si differenziano per una più alta cristallinità, trasparenza e per l'assenza di microporosità.

- **Temperature di utilizzo:**
da -200°C a +205°C.
- **Specifiche:**
Reg. UE 1935/2004, Reg. UE 10/2011.
FDA 177.1550.
D.M. 174 del 06/04/2004.

È responsabilità dell'utente finale verificare la Dichiarazione di Conformità alimentare aggiornata.

Technical Features

FEP is a tetrafluoroethylene and hexafluoropropylene copolymer. Thermoplastic tubing made with this material have physical mechanical characteristics similar to PTFE tubing, but they differ in higher crystallinity, transparency and lack of microporosity.

- **Temperature range:**
from -200°C to +205°C.
- **Specifications:**
Reg. EU 1935/2004, Reg. EU 10/2011.
FDA 177.1550.
D.M. 174 of 06/04/2004.

It is end user responsibility to check the updated Food Declaration of Conformity.

Coefficiente di correzione della pressione di scoppio in funzione della temperatura

Pressure correction factor as function of temperature

Correction Factor

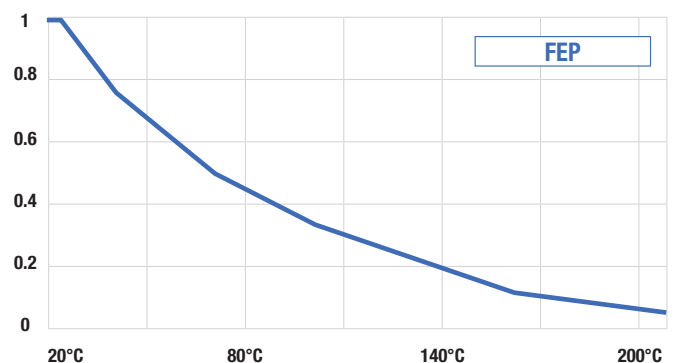

Scheda tecnica - Data Sheet



CODE	mm	mm	mm	bar	mm	g/m
FEP42T	2	4	1	40	8	22
FEP64T	4	6	1	20	30	37
FEP86T	6	8	1	13	45	51
FEP108T	8	10	1	10	100	66
FEP1210T	10	12	1	8	150	80

AT7-PE



Caratteristiche principali

- Pressione da 90 a 200 bar (1.300 a 2.900 psi)
- Anima interna in Polietilene
- Anima interna idonea al passaggio di alimenti, CO2 per uso alimentare ed acqua potabile

Main features

- Pressure from 90 to 200bar (1.300 to 2.900 psi)
- Polyethylene inner core hose
- Inner core suitable for conveying food, CO2 compressed gas and potable water

Caratteristiche tecniche

• Caratteristiche tecnico-costruttive:

Anima interna in polietilene, rinforzo in fibra poliestere ed esterno in poliuretano antiabrasione stabilizzato ai raggi UV e resistente all'idrolisi e ai microrganismi. Tubi microperforati per passaggio aria e gas compatibili.

• Applicazioni:

Le tubazioni della serie AT7-PE sono state create per applicazioni a media pressione, per le quali sia richiesta una materia prima dell'anima interna idonea al contatto con fluidi alimentari.

• Temperature di utilizzo:

da -20°C a +40°C (da -4°F a +104°F)

• Pressioni d'esercizio:

Rapporto di sicurezza 1:4

• Valore max. di vuoto:

0.93 bar; 700 mm Hg

• Specifiche:

Reg. UE 1935/2004, Reg. UE 10/2011.
FDA 21 CFR 177.1520.
D.M. 174 del 06/04/2004.

È responsabilità dell'utente finale verificare la Dichiarazione di Conformità alimentare aggiornata.

Technical Features

• Technical-constructive features:

Inner core in polyethylene, polyester textile reinforcement and exterior covering in antiabrasion polyurethane stabilized against UV rays and resistant to hydrolysis and microorganisms, micro perforated for air and compatible gases.

• Applications:

AT7-PE hose series have been created for the medium pressure conduction of foodstuff, suitable for outdoor applications in MARINE environments having a high percentage of humidity.

• Working temperature:

from -20°C to +40°C (from -4°F to +104°F)

• Working pressure:

Safety ratio 1:4

• Vacuum Rating:

0.93 bar; 700 mm Hg

• Specifications:

Reg. EU 1935/2004, Reg. EU 10/2011.
FDA 21 CFR 177.1520.
Italian DM 174 of 06/04/2004.

It is end user responsibility to check the updated Food Declaration of Conformity.

Scheda tecnica - Data Sheet



CODE	inch	mm	-dash	DN	inch	mm	bar	psi	mm	inch	g/m	lbs/ft	Ferrule Code
AT737100PE	1/4"	6.4	-4	6	0.465	11.8	200	2900	35	1.38	84	0.056	BP14R7
AT757100PE	3/8"	9.7	-6	10	0.630	16.0	175	2537	55	2.17	144	0.097	BP38R7V
AT767100PE	1/2"	13.0	-8	12	0.799	20.3	140	2030	75	2.95	200	0.135	BP12R7V
AT787100PE	3/4"	19.2	-12	19	1.043	26.5	90	1305	145	5.71	294	0.198	BP134R7

PTFE

SINGOLA TRECCIA INOX AISI 304 SINGLE AISI 304 BRAID



Caratteristiche principali

- Pressione da 65 a 200 bar
- Piccolo spessore
- Temperatura di utilizzo fino a 260°C
- Disponibile con anima in 3 spessori differenti

Main features

- Pressure from 65 to 200 bar
- Small thickness
- Working temperature up to 260°C
- Available with 3 different core thicknesses

Caratteristiche tecniche

• **Applicazioni:**
Le tubazioni della serie PTFE singola treccia inox sono adatte per la conduzione di vapore e di tutti i tipi di fluidi alimentari anche ad alte temperature. Queste tubazioni non dissipano le cariche elettrostatiche in presenza di fluidi non conduttivi.

• **Temperature di utilizzo:**
da -60°C a +260°C Da -76°F a +500°F

• **Specifiche**
Reg. UE 1935/2004, Reg. UE 10/2011.
FDA 21 CFR 177.1550.
D.M. 174 del 06/04/2004.

È responsabilità dell'utente finale verificare la Dichiarazione di Conformità alimentare aggiornata.

Technical Features

• **Applications:**
The PTFE single stainless steel braid hoses are suitable for conveying steam and all food types also at high temperature. These hoses do not dissipate electrostatic charges when conveying non-conducting fluids.

• **Temperature range:**
from -60°C to +260°C From -76°F to +500°F

• **Specifications:**
Reg. EU 1935/2004, Reg. EU 10/2011.
FDA 21 CFR 177.1550.
Italian D.M. 174 of 06/04/2004.

It is end user responsibility to check the updated Food Declaration of Conformity.

Coefficiente di correzione della pressione di scoppio in funzione della temperatura Pressure correction factor as function of temperature

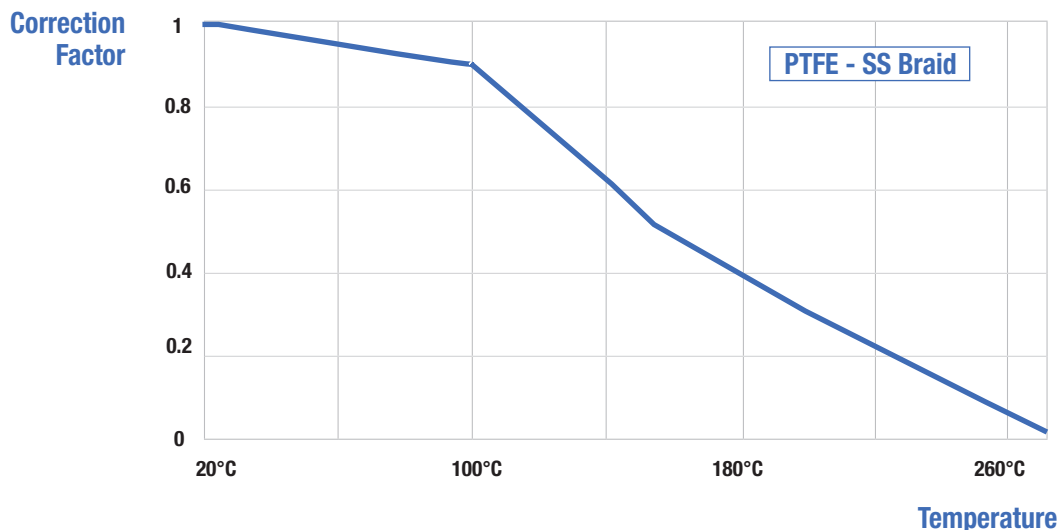

Scheda tecnica Data Sheet



CODE	inch	mm	-dash	DN	inch	mm	mm	inch	bar	psi	mm	inch	g/m	lbs/ft	Ferrule code
PTFE316IP	3/16"	4.8	-3	5	0.29	7.4	0.7	0.027	200	2900	35	1.37	69	0.046	BP316PTFEIP
PTFE14IP	1/4"	6.35	-4	6	0.34	8.9	0.7	0.027	175	2540	45	1.77	87	0.058	BP14PTFEIP
PTFE516IP	5/16"	8.0	-5	8	0.43	10.9	0.7	0.027	150	2170	50	1.96	127	0.085	BP516PTFEIP
PTFE38IP	3/8"	9.5	-6	10	0.47	12.4	0.7	0.027	135	1960	55	2.16	145	0.097	BP38PTFEIP
PTFE12IP	1/2"	12.7	-8	12	0.61	15.7	0.7	0.027	120	1740	70	2.75	212	0.142	BP12PTFEIP
PTFE58IP	5/8"	16.0	-10	16	0.75	19.1	0.7	0.027	100	1450	130	5.11	260	0.175	BP58PTFEIP
PTFE34IP	3/4"	19.0	-12	19	0.87	22.2	0.8	0.031	90	1310	190	7.48	321	0.216	BP34PTFEIP
PTFE1IP	1"	25.4	-16	25	1.14	29.3	0.8	0.031	65	940	270	10.62	450	0.302	BP1PTFEIP



CODE	inch	mm	-dash	DN	inch	mm	mm	inch	bar	psi	mm	inch	g/m	lbs/ft	Ferrule code
PTFE18IM	1/8"	3.2	-2	3	0.25	6.5	1.0	0.039	275	3990	25	0.98	70	0.047	BP180L5
PTFE316IM	3/16"	4.8	-3	5	0.30	7.8	0.9	0.035	200	2900	35	1.37	90	0.060	BP316PTFEIP
PTFE14IM	1/4"	6.35	-4	6	0.37	9.4	0.9	0.035	175	2540	45	1.77	110	0.074	BP14PTFEIP
PTFE516IM	5/16"	8.0	-5	8	0.44	11.3	0.9	0.035	150	2170	50	1.96	150	0.101	BP516PTFEIP
PTFE38IM	3/8"	9.5	-6	10	0.50	12.8	0.9	0.035	135	1960	55	2.16	172	0.116	BP38PTFEIP
PTFE12IM	1/2"	12.7	-8	12	0.63	16.2	0.9	0.035	120	1740	70	2.75	244	0.164	BP12PTFEIP
PTFE58IM	5/8"	16.0	-10	16	0.76	19.5	0.9	0.035	100	1450	130	5.11	300	0.202	BP58PTFEIP
PTFE34IM	3/4"	19.0	-12	19	0.88	22.6	1.0	0.039	90	1310	190	7.48	367	0.247	BP34PTFEIP
PTFE1IM	1"	25.4	-16	25	1.17	29.7	1.1	0.043	65	940	270	10.62	503	0.338	BP1PTFEIP



CODE	inch	mm	-dash	DN	inch	mm	mm	inch	bar	psi	mm	inch	g/m	lbs/ft	Ferrule code
PTFE18IG	1/8"	3.2	-2	3	0.26	6.7	1.1	0.043	275	3990	25	0.98	85	0.057	BP180L5
PTFE316IG	3/16"	4.8	-3	4	0.34	8.6	1.2	0.047	200	2900	50	1.37	105	0.071	BP316PTFEIP
PTFE14IG	1/4"	6.35	-4	6	0.38	9.9	1.2	0.047	175	2540	100	3.93	126	0.085	BP14PTFEIP
PTFE516IG	5/16"	8.0	-5	8	0.47	12.0	1.2	0.047	150	2170	120	4.72	172	0.116	BP516PTFEIP
PTFE38IG	3/8"	9.5	-6	10	0.52	13.4	1.2	0.047	135	1960	130	5.11	207	0.139	BP38PTFEIP
PTFE12IG	1/2"	12.7	-8	12	0.65	16.7	1.2	0.047	120	1740	160	6.29	293	0.197	BP12PTFEIP
PTFE58IG	5/8"	16.0	-10	16	0.79	20.1	1.3	0.051	100	1450	190	7.48	360	0.242	BP58PTFEIP
PTFE34IG	3/4"	19.0	-12	19	0.92	23.4	1.3	0.051	90	1310	200	9.00	423	0.284	BP34PTFEIP
PTFE1IG	1"	25.4	-16	25	1.19	30.3	1.4	0.055	65	940	310	12.20	640	0.430	BP1PTFEIP

PTFEIC

CORRUGATO TRECCIA INOX AISI 304
CORRUGATED AISI 304 BRAID

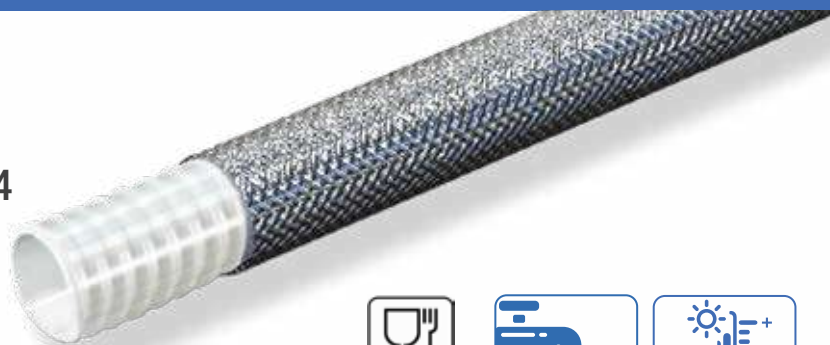

Caratteristiche principali

- Pressione di esercizio da 36 a 120 bar
- Temperatura di utilizzo fino a 260°C

Main features

- Working pressure from 36 to 120 bar
- Working temperature up to 260°C

Caratteristiche tecniche

• **Caratteristiche tecnico-costruttive:**
Anima interna in PTFE corrugato e rinforzo con una treccia in acciaio Inox AISI 304.

• **Applicazioni:**
Le tubazioni della serie PTFE Corrugata Inox sono state create principalmente per la conduzione ad alta pressione di vernici, oli, aria, acqua, fluidi a base acquosa in genere e vapore, nei casi in cui sia richiesta una particolare flessibilità della tubazione data dall'anima interna corrugata. Queste tubazioni non dissipano le cariche elettrostatiche in presenza di fluidi non conduttivi.

• **Temperature di utilizzo:**
da -60°C a +260°C Da -76°F a +500°F

• **Specifiche:**
Reg. UE 1935/2004, Reg. UE 10/2011.
FDA 21 CFR 177.1550. D.M. 174 del 06/04/2004.

È responsabilità dell'utente finale verificare la Dichiarazione di Conformità alimentare aggiornata.

Technical Features

• **Technical-constructive features:**
Inner core in corrugated PTFE and reinforcement braid in AISI 304 stainless steel.

• **Applications:**
hoses of the corrugated STAINLESS STEEL PTFE series have been created mainly for the high pressure conduction of paints, oils, air, water, water-based fluids in general and steam, here the particular type of hose flexibility, offered by the internal corrugated core, is required. These hoses do not dissipate electrostatic charges when conveying non-conductive fluids.

• **Temperature range:**
from -60°C to +260°C From -76°F to +500°F

• **Specifications:**
Reg. EU 1935/2004, Reg. EU 10/2011.
FDA 21 CFR 177.1550. Italian D.M. 174 of 06/04/2004

It is end user responsibility to check the updated Food Declaration of Conformity.

Coefficiente di correzione della pressione di scoppio in funzione della temperatura

Pressure correction factor as function of temperature

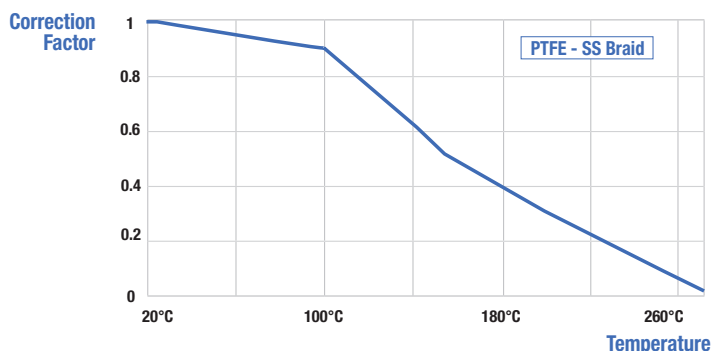

Scheda tecnica Data Sheet



CODE	inch	mm		-dash	DN	mm		bar	psi	mm	inch	g/m	lbs/ft	Ferrule code
		min.	max.			min.	max.							
PTFE38IC	3/8"	9.2	10.2	-6	10	15	16.2	120	1740	30	1.18	208	0.140	BP38PTFEIC
PTFE12IC	1/2"	12.2	13.2	-8	12	17.3	18.9	110	1595	40	1.57	265	0.178	BP12PTFEIC
PTFE58IC	5/8"	15.5	16.5	-10	16	22.1	23.5	80	1160	50	1.96	325	0.218	BP58PTFEIC
PTFE534IC	3/4"	18.4	19.7	-12	19	25.3	27.5	70	1015	80	3.14	387	0.260	BP34PTFEIC
PTFE1IC	1"	24.5	26.3	-16	25	31.7	34.3	50	725	100	3.93	545	0.366	BP1PTFEIC
PTFE114IC	1" 1/4	31	33	-20	32	39	42	45	652	120	4.72	740	0.497	BP114PTFEIC
PTFE112IC	1" 1/2	36.6	39.4	-24	38	44.8	49.2	40	580	140	5.51	860	0.578	BP112PTFEIC
PTFE2IC	2"	49.3	52.7	-32	51	58.7	63.6	36	522	175	6.88	1180	0.793	BP2PTFEIC

MT1HT-PTFE OILPROOF COVER

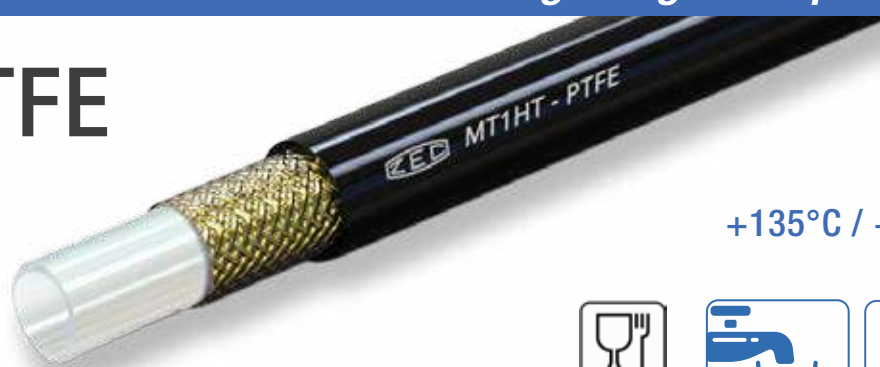

+135°C / +275°F



Caratteristiche principali

- Anima interna in PTFE idoneo per il contatto con gli alimenti
- Per la conduzione ad alta pressione e alta temperatura di acqua e fluidi a base acquosa

Main Features

- Inner core in PTFE suitable for contact with food
- High pressure and high temperature oils, polyols, solvents, but also food and beverage

Caratteristiche tecniche

• Caratteristiche tecnico-costruttive:

Anima interna in PTFE idoneo per il contatto con alimenti, rinforzo con una treccia in acciaio ad alta resistenza e rivestimento esterno in poliuretano antiabrasione a richiesta microperforato per passaggio aria e gas compatibili.

• Applicazioni:

Le tubazioni della serie MT1HT-PTFE sono state create per la conduzione ad alta pressione e alta temperatura di olii idraulici, sostanze chimiche corrosive e prodotti alimentari.

• Temperature di utilizzo:

Da -40°C a +135°C (da -40°F a +275°F).

• Pressioni d'esercizio:

Rapporto di sicurezza 1:4

• Valore max. di vuoto:

0.93 bar; 700 mm Hg

• Specifiche:

Tubazioni conformi o superiori alle pressioni delle norme SAE 100R1 - EN 853 1ST, 1SN - EN 857 1SC - MSHA. Reg. UE 1935/2004, Reg. UE 10/2011. FDA 21 CFR 177.1550. D.M. 174 del 06/04/2004.

È responsabilità dell'utente finale verificare la Dichiarazione di Conformità alimentare aggiornata.

Technical Features

• Technical-constructive features:

Inner core in PTFE suitable to be in contact with food, reinforcement in high tensile steel braid and external cover in antiabrasion polyurethane, micro perforated on request for the conduction of air and compatible gases.

• Applications:

MT1HT-PTFE hose series have been created for the high pressure conduction of hydraulic oils, corrosive chemicals and food at high temperature.

• Temperature range:

From -40°C to +135°C (-40°F to +275°F).

• Working pressure:

Safety ratio 1:4

• Vacuum Rating:

0.93 bar; 700 mm Hg

• Specifications:

Meet or exceed pressures under SAE 100R1 - EN 853 1ST, 1SN - EN 857 1SC, MSHA Standards. Reg. EU 1935/2004, Reg. EU 10/2011. FDA 21 CFR 177.1550. Italian D.M. 174 of 06/04/2004.

It is end user responsibility to check the updated Food Declaration of Conformity.

Scheda tecnica - Data Sheet



CODE	inch	mm	-dash	DN	inch	mm	bar	psi	mm	inch	g/m	lbs/ft	FERRULE CODE
MT110000HT	1/8"	3.5	-2	3	0.295	7.5	375	5437	30	1.18	76	0.051	BP18MT1
MT120000HT	3/16"	4.8	-3	5	0.394	10.0	350	5075	30	1.18	133	0.089	BP316R7
MT130000HT	1/4"	6.4	-4	6	0.469	11.9	300	4350	40	1.57	165	0.111	BP14MT1
MT140000HT	5/16"	8.0	-5	8	0.551	14.0	240	3480	50	1.97	205	0.138	BP516R7V
MT150000HT	3/8"	9.7	-6	10	0.630	16.0	225	3262	60	2.36	253	0.170	BP38R7V
MT160000HT	1/2"	13.0	-8	12	0.756	19.2	190	2755	75	2.95	314	0.211	BP12R7V
MT170000HT	5/8"	16.3	-10	16	0.917	23.3	150	2175	110	4.33	406	0.273	BP58R7V
MT180000HT	3/4"	19.2	-12	19	1.003	25.5	130	1885	150	5.91	447	0.300	BPI34R9R

ACCESSORI

PRESSE MANUALI E PNEUMATICHE / MANUAL AND PNEUMATIC PRESS



PRESSA MANUALE PMZ47 / MANUAL PRESS PMZ47

PRESSA PNEUMATICA PPZ47 / PNEUMATIC PRESS PPZ47



DATI TECNICI / TECHNICAL DATA	CODICE / CODE	
	PMZ47	PPZ47
FORZA DI PRESSATURA / CRIMPING FORCE	100 TON (110 US TONS)	100 TON (110 US TONS)
CAPACITÀ / CAPACITY	1"	1"
Ø MASSIMO / MAX Ø	46 mm* (1.811")	46 mm* (1.811")
APERTURA MORSETTI / DIE OPENING	Ø + 20 mm (Ø + 0.788")	Ø + 20 mm (Ø + 0.788")
RACCORDI A 90° / 90° FITTINGS	3/8"	3/8"
DIMENSIONI PRESSA LxPxH / DIMENSIONS LxWxH	390x510x300 mm (15.3"x20.7"x11.8")	380x430x400 mm (14.9"x16.9"x15.7")
PESO / WEIGHT	32 Kg (71 Lbs)	38 Kg (84 Lbs)
SFORZO SULLA LEVA / REQUIRED EFFORT ON THE LEVER	30 Kg (66 Lbs)	-
ALIMENTAZIONE PNEUMATICA / PNEUMATIC INPUT	-	max 7 Bar (100 Psi)
CILINDRO / CYLINDER	SEMPLICE EFFETTO / SINGLE ACTING	SEMPLICE EFFETTO / SINGLE ACTING

ACCESSORI INCLUSI / INCLUDED ACCESSORIES



CASSETTO PORTA MORSETTI / DIE HOLDER DRAWER

OLIO 2,5 LT. (per PRESSA PNEUMATICA) / 2,5 LT. OIL (for PNEUMATIC PRESS)

MORSETTI / DIES#	PMZ47 - PPZ47											
 DIAMETRO MORSETTI / DIE SET DIAMETER	6	8	10	12	14	16	19	22	25	29	39*	
 LUNGHEZZA MORSETTI / DIE LENGTH	55	55	55	55	55	55	55	55	65	65	64	
CODICE / PART N. MPRESSA-	PPZ476	PPZ478	PPZ4710	PPZ4712	PPZ4714	PPZ4716	PPZ4719	PPZ4722	PPZ4725	PPZ4729	-	

*Porta morsetti - Die holder

#Un diametro di morsetti a scelta compreso nella fornitura della pressa - One die set chosen by customer included with the press

ACCESSORI / OPTIONAL



UTENSILE CAMBIO MORSETTI / TOOL FOR DIE CHANGE
Part. N.: MPZ47UCM

ACCESSORIES

SPIRALI DI PROTEZIONE / PROTECTION SPIRALS

Accessorio per montaggio spirali / Assembly Kit

Confezione / Packs



Specifiche tecniche:

- Spirale realizzata in polietilene ad alta densità e pratica rapida, semplice nel montaggio.
- Indicate per la protezione o il contenimento di uno o più tubi.
- Buona resistenza all'abrasione ed ai raggi UV.

Temperatura di esercizio:

- Da -50°C a +100°C
- Da -58°F a +212°F

Proprietà del materiale

La materia prima di fabbricazione delle spirali GS, deriva da un particolare processo di estrusione del Polietilene. Questo prodotto presenta caratteristiche di elevata resistenza alla rottura (ERS) e risulta conforme ad AS20170 (Australian Standard), lo stesso che garantisce l'alimentarietà di questo prodotto. Inoltre è garantita la compatibilità chimica con la maggior parte di Oli, Olii, emulsioni e solventi.

Technical features:

- The spiral is made of high-density polyethylene that is practical, quick and simple to fit.
- Suitable for the protection or containment of one or more hoses.
- Good UV and abrasion resistance.

Working temperature:

- From -50°C to +100°C
- From -58°F to +212°F

Material Properties

The raw material from which GS Protection Spiral is produced, is manufactured from high molecular weight extrusion grade polyethylene. The product exhibits extremely good environmental stress crack resistance (ERS) and conforms with the Australian Standard AS2070 – plastic material for food contact use. Moreover, chemical compatibility is granted with most of Oils, Polyols, Emulsions and solvents, thanks to the specific compound.



Codice articolo Article Code	Diametro Interno Internal Diameter	Diametro Esterno Outside Diameter	Spessore medio Wall Thickness	Larghezza bandella Strip width	Peso Weight	Diametri dei tubi Hose diameter range	Pezzatura Length
	mm	mm	mm	mm	g/m	mm	m
GS128	9.5	12	1.7	10	46	10÷17	50
GS1612	12.5	16	1.8	12	76	13÷22	50
GS2016	16	20	1.8	14.5	86	16÷27	50
GS2520	21	25	2	21	112	21÷35	50
GS3227	27	32	2	24	177	27÷44	50
GS4036	34	40	2.5	30	217	34÷55	50
GS5044	44	50	3	35	278	44÷70	50
GS6356	55	63	3.5	40	588	55÷87	20
GS7567	66	75	3.4	40	813	67÷103	20
GS9080	79	90	5	45	1033	80÷122	20
GS110100	99	110	5.5	55	1200	100÷152	12
GS125114	114	125	5.6	55	1638	115÷174	12
GS140129	129	140	5.6	55	1807	130÷196	8
GS160148	148	160	6	60	2031	150÷224	6

ACCESSORI

BOBINE DI CARTONE / CARTON BOARD REELS

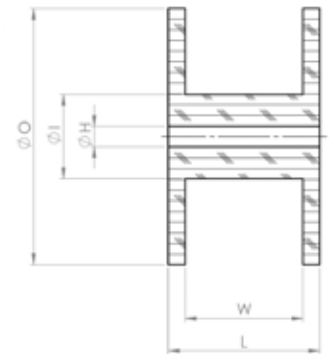

Codice Bobina Reel Code	Esterno Outside Ø O (mm)	Interno Inside Ø I (mm)	Foro Hole Ø H (mm)	Larghezza Width W (mm)	Lunghezza Length L (mm)	Tara Tare (Kg)
IBC470250300	470	250	40	300	330	0.4
IBC550400400	550	400	60	400	430	1.7
IBC550400500	550	400	60	500	530	2
IBC600400400	600	400	60	400	430	1.9
IBC600400500	600	400	60	500	530	2.1
IBC800400400	800	400	60	400	430	3.3
IBC1060600320	1060	600	84	320	350	5.2
IBC1060600500	1060	600	84	500	530	6

BOBINE IN LEGNO / WOODEN COILS

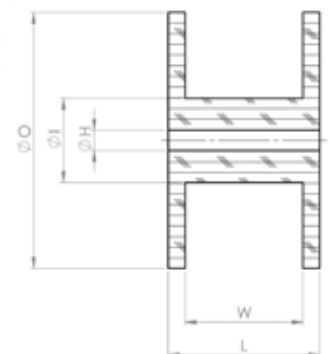

Codice Bobina Reel Code	Esterno Outside Ø O (mm)	Interno Inside Ø I (mm)	Foro Hole Ø H (mm)	Larghezza Width W (mm)	Lunghezza Length L (mm)	Tara Tare (Kg)
IBL500160200	500	160	80	200	220	1.6
IBL500160300	500	160	80	300	320	2.5
IBL630315335	630	315	80	335	403	13
IBL700400470	700	400	80	470	500	12
IBL800400470	800	400	80	470	538	23
IBLDIN1000	1000	500	80	580	668	37
IBLDIN1200	1200	600	82	610	644	32
IBLDIN1400	1400	710	82	750	858	103
IBLDIN1600	1600	710	82	900	1028	225

ACCESSORIES

PROTEZIONI PER TUBI HBR - HOSE BEND RESTRICTORS / PROTECTIONS FOR HBR HOSES - HOSE BEND RESTRICTORS

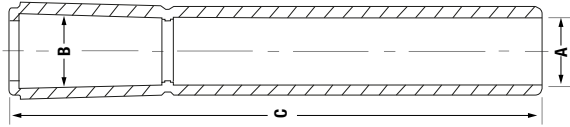

Codice / Code	A (mm)	B (mm)	C (mm)
HBR10	13.2	16.0	151
HBR20	15.6	17.7	134
HBR40	17.0	19.2	146
HBR60	19.0	21.6	160.5
HBR80	20.7	23.5	177
HBR100	22.1	25.3	197

Descrizione:

Manicotti di protezione in Vinile di colore nero, idonei per la riduzione dello stress a flessione della tubazione nella zona della raccordatura.

Temperatura di esercizio:

Da +5°C a +80°C Da +41°F a +176°F

Description:

black vinyl protection sleeves, suitable to reduce tube bending stress in the crimping area.

Working Temperature:

From +5°C to +80°C From +41°F to +176°F



INDICAZIONI DI MONTAGGIO INSTALLATION INSTRUCTIONS (SAE J1273 - ISO 8331)

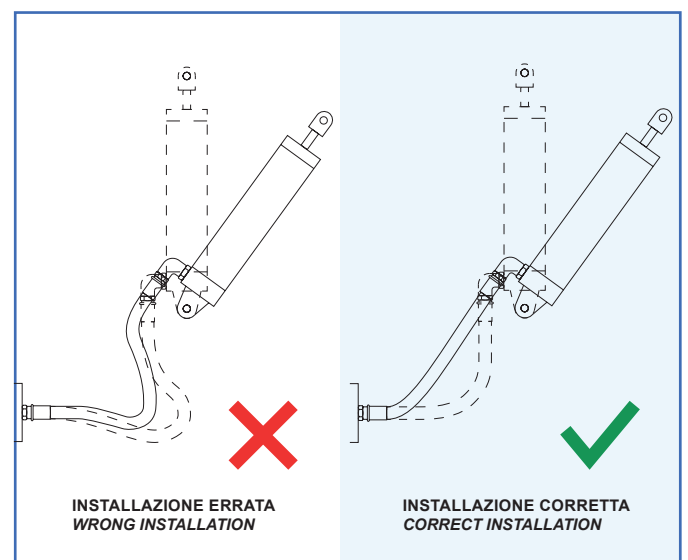
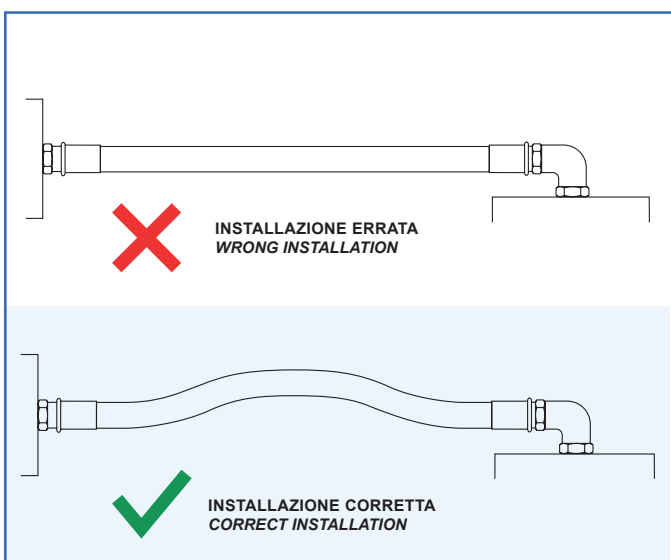
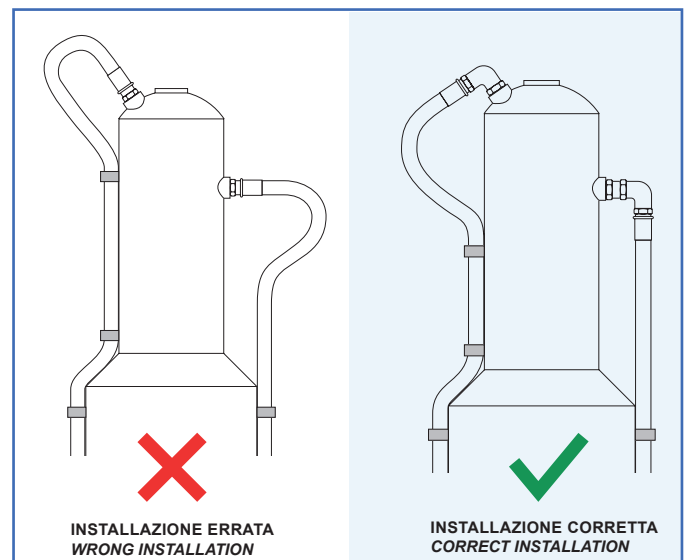
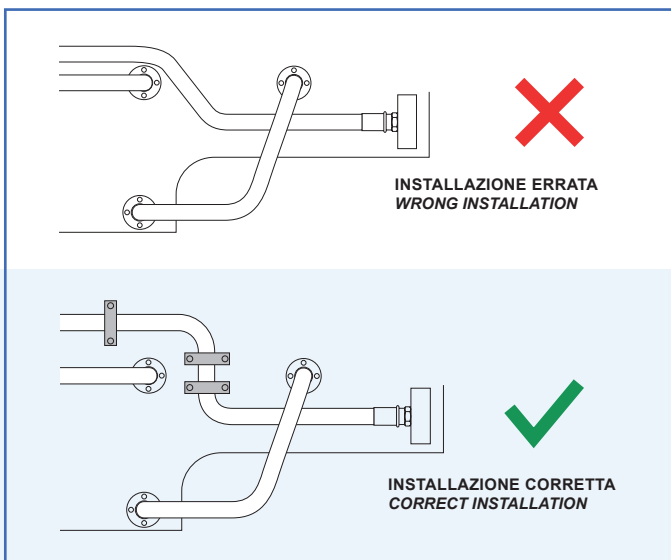
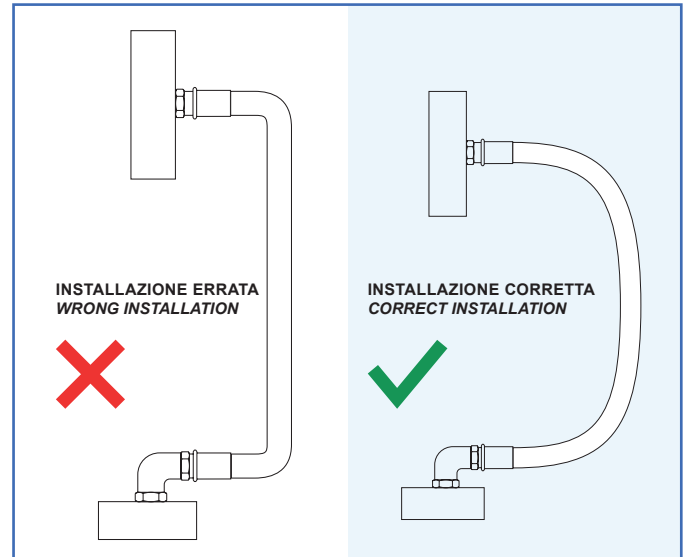
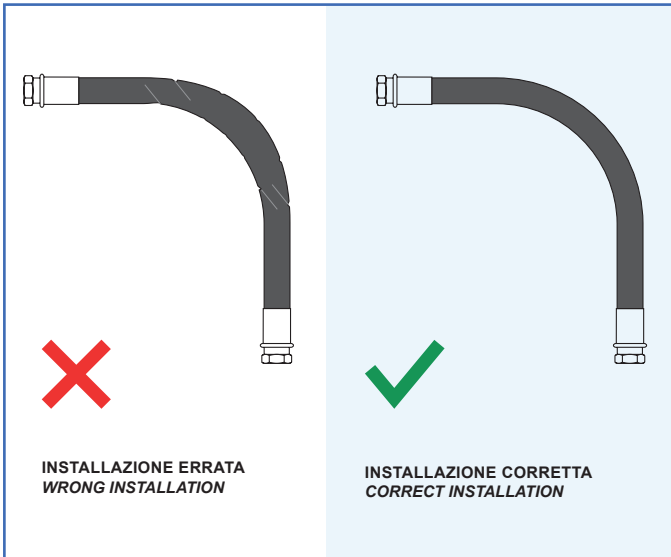

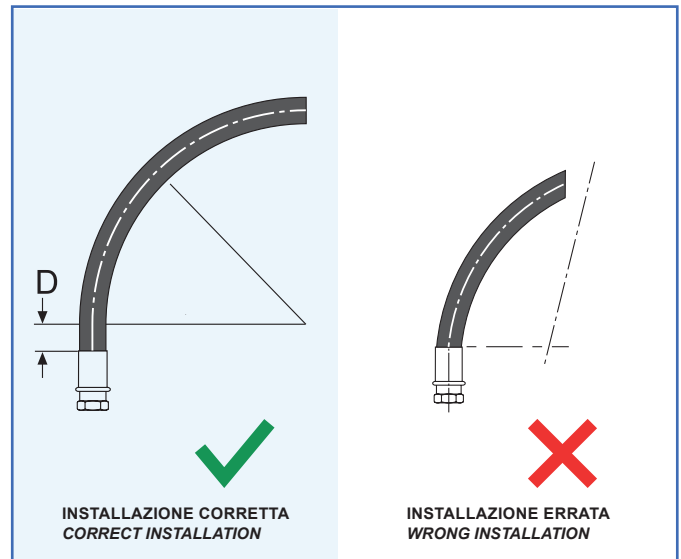
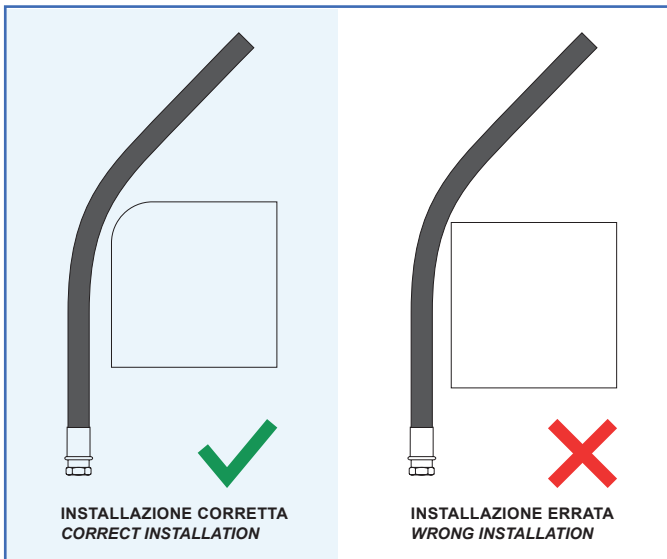

ISTRUZIONI E DATI DI RACCORDATURA CRIMPING DATA AND INSTRUCTIONS

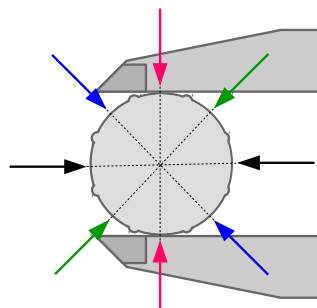

Per una corretta e sicura operazione di raccordatura raccomandiamo l'uso di raccordi e boccole ZEC; istruzioni e diametri di pressatura sono disponibili e sempre aggiornati in Area Riservata sul sito ZEC: www.zecspa.com/it/area-riservata

For a correct and safe crimping operation, we recommend the use of ZEC ferrules and fittings; proper instructions and crimping diameters are available and always updated into Restricted Area on ZEC's web page: www.zecspa.com/en/reserved-area

Le immagini e i valori menzionati in questo documento sono forniti a titolo puramente indicativo al fine di consentire una prima valutazione sulle possibilità di impiego dei prodotti. La Nostra produzione potrà essere variata senza impegno di alcun preavviso alla Nostra clientela.

Si raccomanda di verificare sul sito www.zecspa.com la presenza di possibili adeguamenti per scaricare le schede tecniche di prodotto aggiornate.

È responsabilità del cliente verificare che i tubi e i raccordi siano adatti alla propria applicazione e soddisfino le specifiche e gli standard richiesti.

Per condizioni di vendita: www.zecspa.com/it/condizioni-general-di-vendita.

The images and values indicated in the present document are to be intended only as an indication, with the purpose of permitting the customer a first evaluation of the products application possibilities. Our production can be modified without any obligation of prior notice to our customers.

Therefore we recommend to consult our website www.zecspa.com for the latest version of the technical data sheets.

It's the Customer's responsibility to check that hoses and fittings are suitable for his application and meet the required specifications and standards.

For Terms of Sale please refer to www.zecspa.com/en/general-conditions-of-sale.



Condizioni generali di vendita



General conditions of sale



THERMOPLASTIC TUBING AND HOSES
MADE IN ITALY

ZEC S.p.A.
Via Lungolorno 11, 43052 Colorno (PR) - Italy
Tel. +39 0521 816631 - Fax +039 0521 816772

www.zecspa.com
info@zecspa.com

