



THERMOPLASTIC TUBING AND HOSES  
SINCE 1961



## SERIE JACK HOSE / *JACK HOSE SERIES*



Tubi termoplastici per il settore **oleodinamico ad altissima pressione**  
*Thermoplastic Tubing and Hoses for **Highest Pressure Fluid Power Applications***



THERMOPLASTIC TUBING AND HOSES  
MADE IN ITALY

## Indice / Index

Azienda / Company .....4

Le soluzioni ZEC per il settore oleodinamico ad altissima pressione /  
ZEC solutions for highest pressure fluid power applications.....6

## Tubi termoplastici serie Jack Hose / Thermoplastic Jack Hose Series



JACK HOSE - Pressione statica / JACK HOSE - Static Pressure .....8



JACK HOSE - Pressione dinamica / JACK HOSE - Dynamic Pressure .....9



JACK HOSE - Non conduttivo / JACK HOSE - Non Conductive .....10



Boccole / Ferrule .....11



Raccordi JACK HOSE / JACK HOSE Fittings .....12

## ZEC S.p.A.: Flessibilità per scelta

ZEC S.p.A., fondata nel 1961 da Eugenio Zantelli a Colorno, in provincia di Parma, produce tubi termoplastici per applicazioni a bassa, media, alta e altissima pressione.

A partire dal 1990 le attività commerciali sul mercato domestico sono estese all'espansione sui mercati internazionali.

Investimenti in risorse umane particolarmente qualificate, impianti di produzione tecnologicamente avanzati, attività di ricerca e sviluppo e la presenza commerciale favoriscono l'espansione sui mercati globali, dove ZEC S.p.A. oggi è presente in più di 90 paesi.

La considerevole crescita in tutte le aree è stata accompagnata da una gamma di prodotti sempre più ampia, dedicata a numerosi settori applicativi, quali oleodinamica, pneumatica, lubrificazione, automotive, alimentare, navale, refrigerazione, petrochimico-offshore, etc..

La gamma di prodotti di ZEC S.p.A. comprende tubi termoplastici standard o customizzati singoli, multipli e spiraliati, con caratteristiche tecniche da 2mm a 40mm di diametro interno, pressioni di lavoro da 5bar a 1280bar e temperature di esercizio da -200°C a +260°C.

Tutti i tubi termoplastici di ZEC S.p.A. sono prodotti di materie prime di primaria qualità accuratamente selezionate. Ogni fase del ciclo produttivo è soggetta a severi controlli qualitativi.

La produzione avviene esclusivamente all'interno dei ns. stabilimenti a Colorno, Italia.

I prodotti finiti sono conformi alle principali normative internazionali dei rispettivi settori applicativi, quali SAE, EN, ISO e DIN.

ZEC S.p.A. opera in regime di qualità UNI EN ISO 9001-2015.

## ZEC S.p.A.: Flexibility for Choice

*ZEC S.p.A., founded in 1961 by Mr. Eugenio Zantelli in Colorno, Province of Parma, Italy, manufactures thermoplastic tubing and hoses for low, medium, high and very high pressure applications.*

*Domestic business activities are boosted by an International breakthrough as of 1990.*

*Investments in special skilled human resources, manufacturing, product innovations and commercial presence elevates ZEC S.p.A. meanwhile into the global market, covering more than 90 countries worldwide.*

*Significant growth in all areas have been accompanied with an ever increasing product range dedicated to a large portfolio of applications such as fluid power, pneumatics, lubrication, automotive, food processing, marine, refrigeration, petrochemical-offshore, and so on.*

*The ZEC S.p.A. product range includes standard or customized single, multiple and coiled thermoplastic tubing and hoses, with technical characteristics within the range of 2mm to 40mm inner diameter, working pressures from 5bar to 1280bar and operating temperatures from -200°C to +260°C.*

*All products manufactured by ZEC S.p.A. are of top quality and carefully selected raw materials. Manufacturing processes are continuously multiple controlled.*

*The entire production takes place in our facilities located in Colorno, Italy.*

*End products comply strictly with major international standards such as SAE, EN, DIN & ISO.*

*All company sectors and activities are qualified and operate according to UNI EN ISO 9001-2015 quality system.*



*Thermoplastic Jack Hose Series*

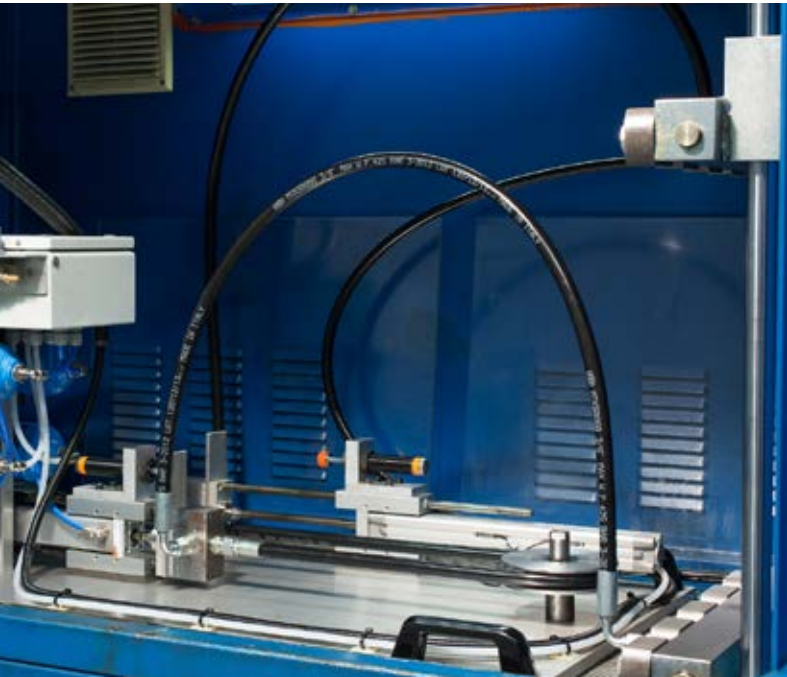
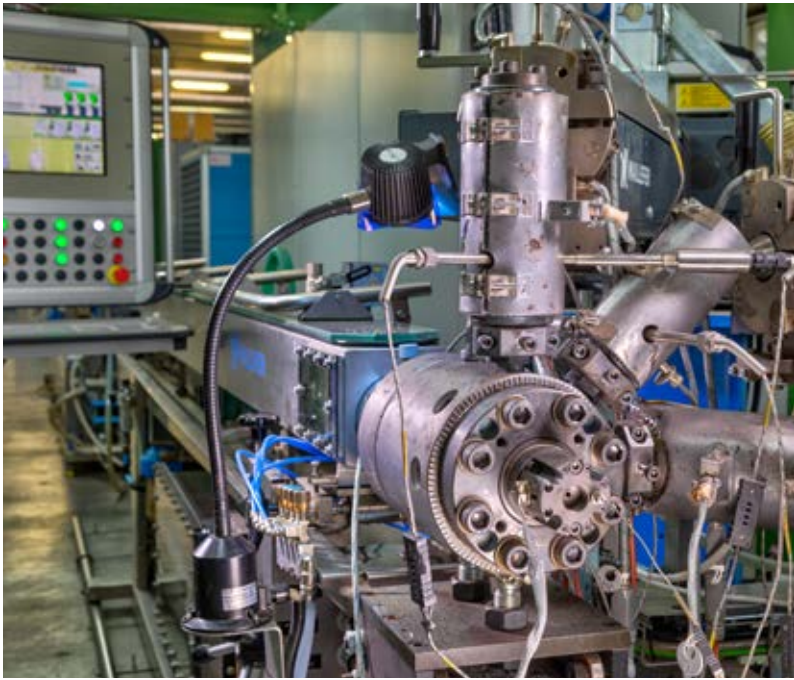
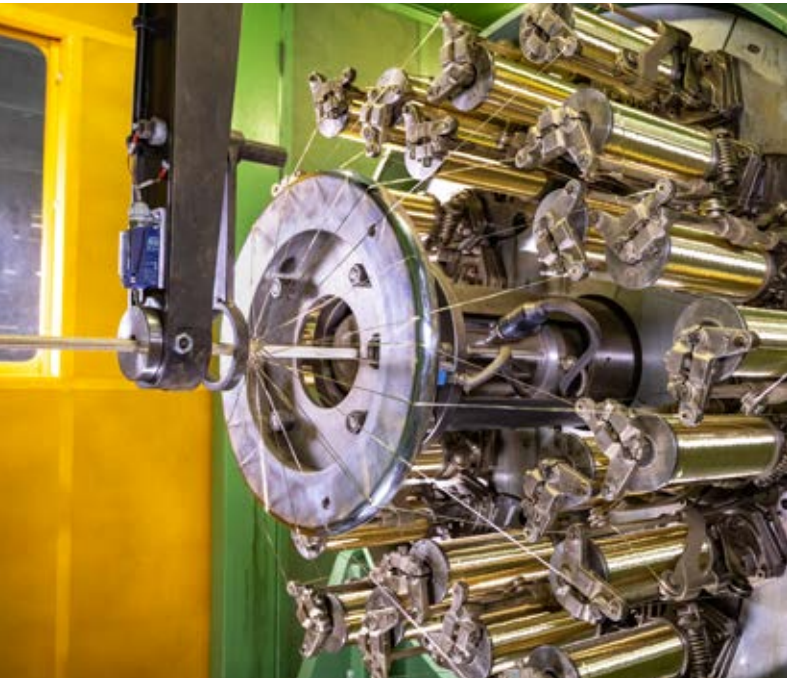



## Le soluzioni ZEC per il settore oleodinamico ad altissima pressione

La gamma di tubi **ZEC serie Jack Hose** è ideale per la conduzione di polioli e fluidi idraulici per sistemi statici e dinamici ad altissima pressione utilizzati nel settore delle costruzioni, della sicurezza, minerario, navale ed offshore.

### APPLICAZIONI

I tubi Jack Hose sono utilizzati in applicazioni oleodinamiche, quali:

- cilindri di sollevamento
- pompe manuali
- attrezzature di soccorso
- sistemi idraulici di tensionamento

### NORMATIVE

I tubi ZEC della serie Jack Hose sono conformi alla normativa **MSHA (IC-332/06) (Mine Safety and Health Administration)**. La certificazione MSHA è riconosciuta in tutto il mondo come referenza per applicazioni minerarie. A causa delle severe prescrizioni in merito alla resistenza alle fiamme, secondo il regolamento 30 CFR Part. 18 Sec. 18.65, è stata adottata anche per applicazioni non connesse al settore minerario, ove la resistenza alla fiamma è obbligatoriamente richiesta.

#### Caratteristiche e benefici dei tubi ZEC Jack Hose:

- Alte prestazioni per il sollevamento di carichi pesanti
- Copertura **MSHA (IC-332/06)** ed **antiabrasione**
- **Disponibilità di tutte le connessioni** richieste sul mercato

Tutti i tubi ZEC sono prodotti in conformità al regolamento **EU 1907/2006 "REACH"** ed alla **Direttiva EU 2011/65 "RoHS"**. Le dichiarazioni sono disponibili su: <https://www.zecspa.com/it/supporto-tecnico>

## ZEC solutions for highest pressure fluid power applications

*ZEC Jack Hose Series is suitable for the high pressure conduction of polyols and hydraulic fluids in static and dynamic systems used in construction, safety, mining, shipbuilding and offshore field.*

### APPLICATIONS

Jack Hoses are used in fluid power applications, such as:

- *lifting cylinders*
- *manual pumps*
- *rescue tools*
- *hydraulic tensioning systems*

### STANDARDS

*ZEC Jack Hoses meet or exceed **MSHA (IC-332/06) (Mine Safety and Health Administration) Standards**. The MSHA approval is recognized as reference for mining applications all over the world. Due to the severe flame resistance requirements, according to 30 CFR Part 18 Sec. 18.65, it has been adopted also to non-mining related applications, where flame resistance is mandatorily required.*

#### Features and benefits of ZEC Jack Hose:

- *High performance for **heavy lifting***
- ***MSHA (IC-332/06)** and **anti-abrasion** cover*
- ***Availability of all connections** required by the market*

*All ZEC hoses are manufactured in conformity to **European Regulation EU 1907/2006 "REACH"** and **European Directive EU 2011/65 "RoHS"**. Both declarations are available on: <https://www.zecspa.com/en/technical-support>*

*Thermoplastic Jack Hose Series*

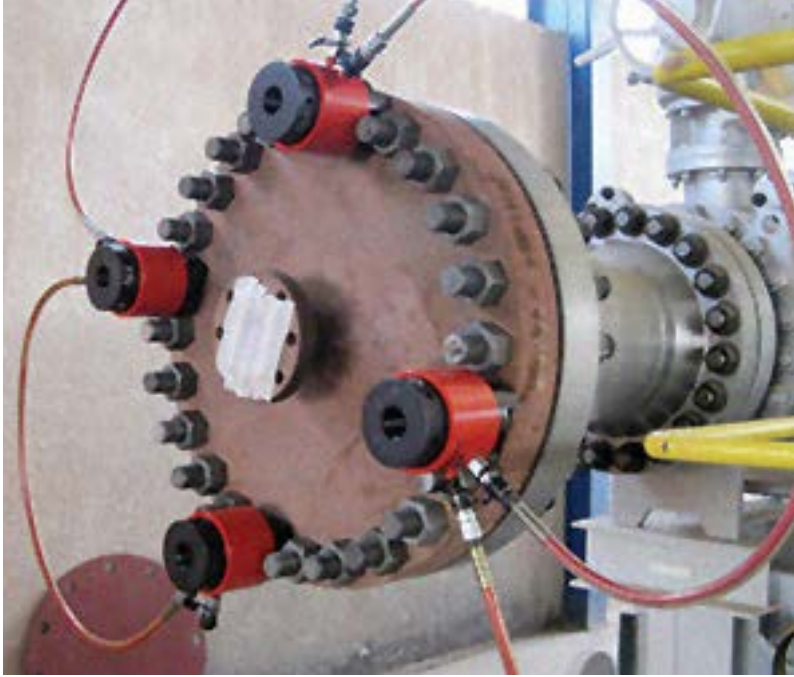
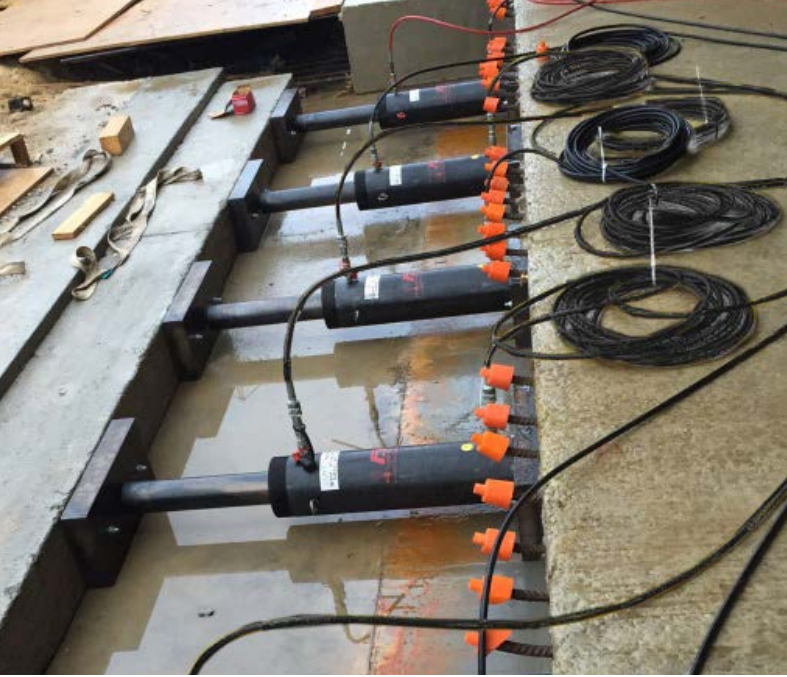
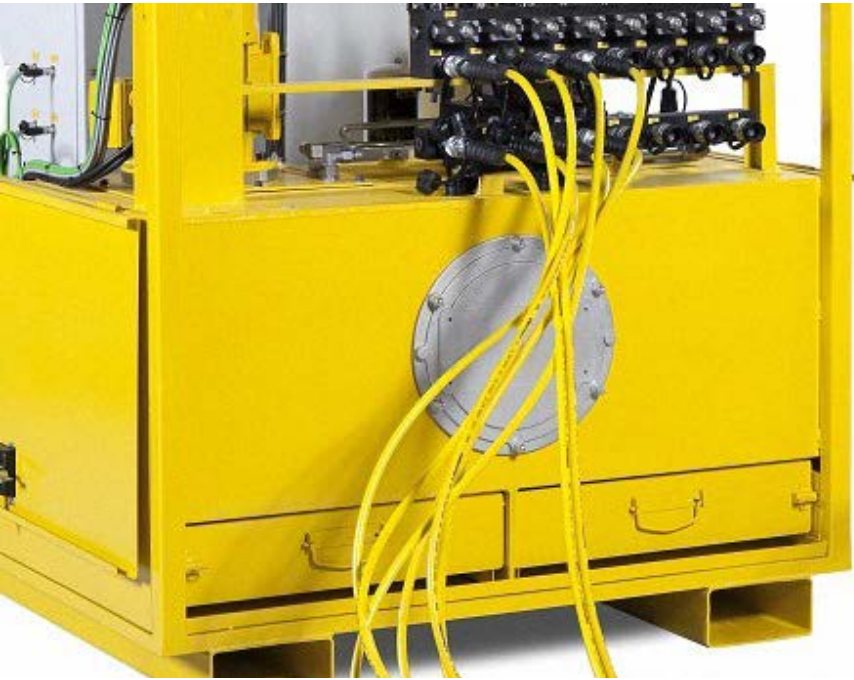



## JACK HOSE PRESSIONE STATICA STATIC PRESSURE

WATERPROOF COVER



### Caratteristiche principali

- Pressione STATICA di 700bar con rapporto di sicurezza 1:2.5
- Conforme a MSHA (IC-332/06)
- Eccellente resistenza ad abrasione ed idrolisi
- Elevata flessibilità

### Main Features

- **STATIC pressure 700bar with safety ratio 1:2.5**
- **MSHA (IC-332/06) compliant**
- **Excellent abrasion and hydrolysis resistance**
- **High flexibility**

### Caratteristiche tecniche

- **Caratteristiche tecnico-costruttive:**  
Anima interna di poliammide (ad eccezione del MTH2J57000), rinforzo con treccia di fibra aramidica e/o acciaio ad alta resistenza e rivestimento esterno di poliuretano antiabrasione, resistente all'idrolisi, stabilizzato per applicazioni all'esterno, su richiesta microforato per passaggio di aria e gas compatibili.
- **Temperature di utilizzo:**  
Da -40°C a +100°C (-40°F to 212°F)  
Per aria, acqua e fluidi a base acquosa la temperatura massima di esercizio è di +70°C (+158°F).
- **Valore Max. di vuoto:**  
0.93 bar; 700 mm Hg
- **Pressioni d'esercizio:**  
Rapporto di sicurezza 1:2.5
- **Specifiche:**  
Tubazioni conformi o superiori alle norme MSHA (IC-332/06).

### Technical Features

- **Technical-constructive features:**  
*Inner core made of polyamide (with the exception of MTH2J57000), reinforcement of Aramid fiber and/or high tensile steel braids and exterior cover made of antiabrasion polyurethane, resistant to hydrolysis and stabilized for outdoor applications, pinpricked on request for the conduction of air and compatible gases.*
- **Working temperatures:**  
From -40°C to +100°C (-40°F to 212°F)  
*Max. working temperature with air, water and water-based fluids is +70°C (+158°F).*
- **Vacuum rating:**  
0.93 bar; 700 mm Hg
- **Working pressures:**  
Safety ratio 1:2.5
- **Specifications:**  
*Hoses meet or exceed MSHA (IC-332/06) standards.*

### Scheda tecnica - Data Sheet



CODE	inch	-dash	mm	DN	inch	mm	bar	psi	mm	inch	g/m	lbs/ft	FERRULE CODE	INSERTO / TAIL
MT2J37000	1/4"	-4	6.4	6	0.531	13.5	700	10150	40	1.57	296	0.199	BP14R9R	TL
MT2J37000B *	1/4"	-4	6.4	6	0.531	13.5	700	10150	40	1.57	592	0.398	BP14R9R	TL
MTH2J57000#	3/8"	-6	9.7	10	0.701	17.8	700	10150	60	2.36	400	0.269	BP38R9R	TL
MTKJ57000	3/8"	-6	9.7	10	0.709	18.0	700	10150	60	2.36	340	0.228	BP38R9R	TL
MTKJ67000	1/2"	-8	13.0	12	0.866	22.0	700	10150	75	2.95	486	0.327	BP12R9R	TL

#Anima interna in materiale termoplastico poliestere-elastomero (TPE). SF 2,15 :1

- **Colori disponibili:**  
nero ■ (00), rosso ■ (05), giallo ■ (04).  
Modificare gli ultimi due valori dei codici con i rispettivi codici colore.

\* Tubo BINATO, su richiesta anche di due colori diversi.

#Inner core made of Thermoplastic Polyester-Elastomer material (TPE). SF 2,15 :1

- **Available colours:**  
black ■ (00), red ■ (05), yellow ■ (04).  
Change the last two numbers of the codes with the respective colour codes.

\* TWIN-LINE hose, on request also in two different colours.



## JACK HOSE PRESSIONE DINAMICA DYNAMIC PRESSURE

WATERPROOF COVER



### Caratteristiche principali

- Pressione DINAMICA di 700bar con rapporto di sicurezza 1:4
- Conforme a MSHA (IC-332/06)
- Eccellente resistenza ad abrasione ed idrolisi
- Elevata flessibilità e leggerezza

### Main Features

- *Dynamic pressure 700 bar with safety ratio 1:4*
- *MSHA (IC-332/06) compliant*
- *Excellent abrasion and hydrolysis resistance*
- *High flexibility and low weight*

### Caratteristiche tecniche

- **Caratteristiche tecnico-costruttive:**  
Anima interna di poliammide, rinforzo con treccia di fibra aramidica ed acciaio ad alta resistenza e rivestimento esterno in poliuretano antiabrasione, resistente all'idrolisi e stabilizzato per applicazioni all'esterno, su richiesta microforato per passaggio di aria e gas compatibili.
- **Temperature di utilizzo:**  
Da -40°C a +100°C (-40°F to 212°F)  
Per aria, acqua e fluidi a base acquosa la temperatura massima di esercizio è di +70°C (+158°F).
- **Valore Max. di vuoto:**  
0.93 bar; 700 mm Hg
- **Pressioni d'esercizio:**  
Rapporto di sicurezza 1:4  
# Rapporto di sicurezza 1:3.42
- **Specifiche:**  
Tubazioni conformi o superiori alle norme MSHA (IC-332/06), omologazione DNV.

### Technical Features

- **Technical-constructive features:**  
*Inner core made of polyamide, reinforcement of Aramid fiber and high tensile steel braid and exterior cover made of polyurethane, resistant to hydrolysis and stabilized for outdoor applications, pinpricked on request for the conduction of air and compatible gases.*
- **Working temperatures:**  
*From -40°C to +100°C (-40°F to 212°F)*  
*Max. working temperature with air, water and water-based fluids is +70°C (+158°F).*
- **Vacuum rating:**  
0.93 bar; 700 mm Hg
- **Working pressures:**  
*Safety ratio 1:4*  
*# Safety ratio 1:3.42*
- **Specifications:**  
*Hoses meet or exceed, MSHA (IC-332/06) standards, DNV type approval.*

### Scheda tecnica - Data Sheet



CODE	inch	-dash	mm	DN	inch	mm	bar	psi	mm	inch	g/m	lbs/ft	FERRULE CODE	INSERTO / TAIL
MTK37000	1/4"	-4	6.4	6	0.571	14.5	700	10150	40	1.57	242	0.163	BP14R9R	TL
MTK37000B *	1/4"	-4	6.4	6	0.571	14.5	700	10150	40	1.57	484	0.326	BP14R9R	TL
MTKM57000	3/8"	-6	9.7	10	0.740	18.8	700	10150	90	3.54	375	0.257	BP38MTKM	TL
MTKM67000 #	1/2"	-8	13.0	12	0.992	25.2	700	10150	140	5.51	588	0.395	BP12MTKM	S

- **Colori disponibili:**  
nero (00), rosso (05), giallo (04).  
Modificare gli ultimi due valori dei codici con i rispettivi codici colore.

\* Tubo BINATO, su richiesta anche di due colori diversi.

- **Available colours:**  
black (00), red (05), yellow (04).  
Change the last two numbers of the codes with the respective colour codes.

\* TWIN-LINE hose, on request also in two different colours.

## JACK HOSE NON CONDUTTIVO NON CONDUCTIVE

WATERPROOF COVER



### Caratteristiche principali

- Pressione dinamica 700 bar con rapporto di sicurezza 1:4
- MSHA (IC-332/06)
- Soluzione non conduttiva

### Main Features

- *Dynamic pressure up to 700 bar with safety ratio 1:4*
- *MSHA (IC-332/06)*
- *Non conductive solution*

### Caratteristiche tecniche

• **Caratteristiche tecnico-costruttive:**  
Anima interna di poliestere termoplastico, rinforzo con treccia in fibra aramidica e rivestimento esterno di poliuretano polietere antiabrasione arancio, stabilizzato agli UV e resistente ai microrganismi.

• **Temperature di utilizzo:**  
Da -40°C a +100°C (-40°F to 212°F)  
Per aria, acqua e fluidi a base acquosa la temperature massimo di esercizio è +70°C (+158°F).

• **Valore Max. di vuoto:**  
0.93 bar; 700 mm Hg

• **Pressioni d'esercizio:**  
Rapporto di sicurezza 1:4

• **Specifiche:**  
Conformi a SAE J517 §21.4.1 con correnti di perdita minori di 50µA se sottoposti ad una tensione di 250.000 V/m.  
MSHA (IC-332/06).

### Technical Features

• **Technical-constructive features:**  
*Inner core made of thermoplastic polyester, reinforcement of Aramid fiber braid and exterior covering in orange antiabrasion polyether polyurethane, UV-stabilized and microorganisms-resistant.*

• **Working temperatures:**  
*From - 40°C to +100°C (-40°F to 212°F)*  
*Max. working temperature of air, water and water-based fluids is +70°C (+158°F).*

• **Vacuum rating:**  
*0.93 bar; 700 mm Hg*

• **Working pressures:**  
*Safety ratio 1:4*

• **Specifications:**  
*Compliant to SAE J517 §21.4.1 with leakage currents low than 50 µA if subjected to 250.000 V/m tension.*  
*MSHA (IC-332/06).*

### Scheda tecnica - Data Sheet



CODE	inch	-dash	mm	DN	inch	mm	bar	psi	mm	inch	g/m	lbs/ft	FERRULE CODE	INSERTO / TAIL
OL8M37001	1/4"	-4	6.4	6	0.583	14.8	700	10150	50	1.97	159	0.107	BP14R9R	TL
OL8MS57001HP	3/8"	-6	9.7	10	0.709	18.0	700	10150	90	3.54	205	0.138	BP38R9R	TL

Tubazioni conformi alle norme SAE J517 e ISO 3949: con resistenza elettrica minore di 50 µA se sottoposte ad una tensione di 250.000 V/m.

Hoses meet SAE J517 and ISO 3949 standard: with electrical resistance below 50 µA if subjected to 250.000 V/m tension.



## Boccola a pressione per tubo Serie Jack Hose Swage Ferrule for Jack Hose Series

<b>Materiale</b> <i>Material</i>	<b>Carbon steel</b> <i>Surface Finishing</i>
Acciaio AVP <i>Carbon Steel</i>	Zincatura trivalente <i>Zinc Plating</i>

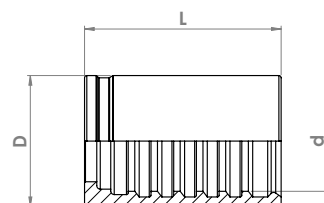

Codice <i>Part Number</i>	Diametro tubo <i>Hose Size</i>			Tubi <i>Hoses</i>	Dimensioni <i>Dimensions (mm)</i>			Tipo di inserto <i>Tail Type</i>
	inch	mm	size		d	D	L	
BP14R9R	1/4"	6.4	04	MT2J / MTK / OL8M	15.3	21	40	TL
BP38R9R	3/8"	9.7	06	MTH2J / MTKJ / OL8MHP	18.7	26	43	TL
BP38MTKM	3/8"	9.7	06	MTKM	21	28	46	TL
BP12R9R	1/2"	13.0	08	MTKJ	23	30	45	TL
BP12MTKM	1/2"	13.0	08	MTKM	27	35	64.5	S

## JACK HOSE - Raccordi raccomandati / Recommended fittings Acciaio AVP - Zincato / Carbon Steel - Zinc Plated

FEMMINA TL BSPP SV. 60° - 700 BAR  
TL FEMALE BSPP 60° CONE - 700 BAR

MASCHIO TL BSPP SV. 60° - 700 BAR  
TL MALE BSPP 60° CONE - 700 BAR

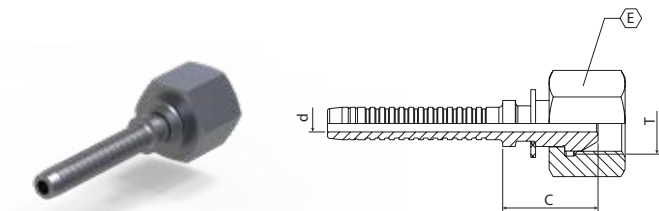

Codice / Part Nr.	Tubo / Hose	T	d	E	C	Utilizzo / Use
		Filetto / Thread	Foro / Hole	Chiave / Hexagon	Cut off	
RTPFD14BP14L	1/4"	1/4"-19	3.5	19	20	Static / Dynamic
RTPFD38BP38L	3/8"	3/8"-19	6.5	24	24	Static / Dynamic
RTPFD12BP12L	1/2"	1/2"-14	9.0	30	29	Static

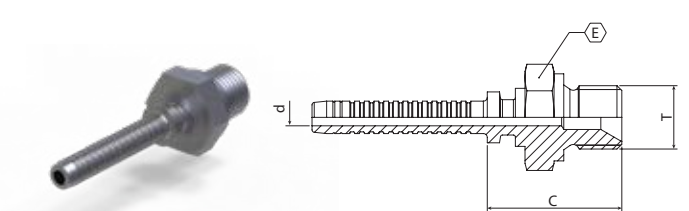

Codice / Part Nr.	Tubo / Hose	T	d	E	C	Utilizzo / Use
		Filetto / Thread	Foro / Hole	Chiave / Hexagon	Cut off	
RTPMD14BP14L	1/4"	1/4"-19	3.5	19	28	Static / Dynamic
RTPMD38BP38L	3/8"	3/8"-19	6.5	22	30	Static / Dynamic
RTPMD12BP12L	1/2"	1/2"-14	9.0	27	34	Static

MASCHIO TL NPT - 700 BAR / MASCHIO TL NPTF - 700 BAR  
TL NPT MALE - 700 BAR / TL MALE NPTF - 700 BAR

FEMMINA TL DKOS SV. 24° - 700 BAR  
TL FEMALE DKOS 24° CONE - 700 BAR

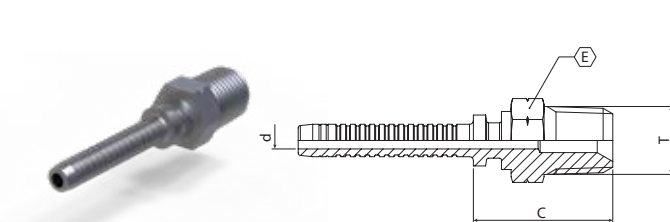

Codice / Part Nr.	Tubo / Hose	T	d	E	C	Utilizzo / Use
		Filetto / Thread	Foro / Hole	Chiave / Hexagon	Cut off	
RTPMD14NC14L	1/4"	1/4"-18	3.5	15	29	Static/Dynamic
RTPMD38NC14L	1/4"	3/8"-18	3.5	19	29	Static/Dynamic
RTPMD38NC38L	3/8"	3/8"-18	6.5	19	29	Static/Dynamic

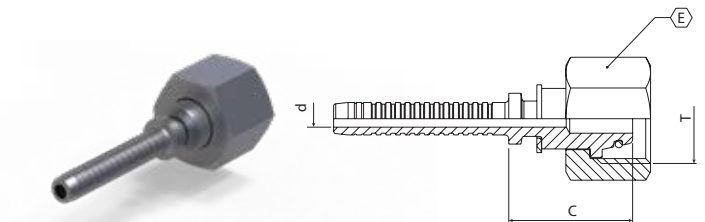

Codice / Part Nr.	Tubo / Hose	T	d	E	C	Utilizzo / Use
		Filetto / Thread	Foro / Hole	Chiave / Hexagon	Cut off	
RTPFD16S14L	1/4"	M16-1.5	3.5	19	27	Static / Dynamic
RTPFD18S14L	1/4"	M18-1.5	3.5	22	26	Static / Dynamic
RTPFD20S38L	3/8"	M20-1.5	6.5	24	28	Static / Dynamic
RTPFD24S12L	1/2"	M24-1.5	9.0	30	31	Static



# Thermoplastic Jack Hose Series

FEMMINA TL JIC SV.74° - 700 BAR  
TL FEMALE JIC 74° CONE - 700 BAR

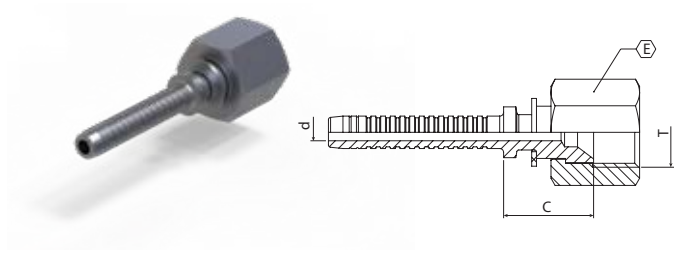

RACCORDI S PER TUBO 1/2" JACK HOSE TIPO MTKM  
PER UTILIZZO DINAMICO - 700 BAR  
S FITTINGS FOR 1/2" HOSE JACK HOSE MTKM TYPE  
FOR DYNAMIC USE - 700 BAR

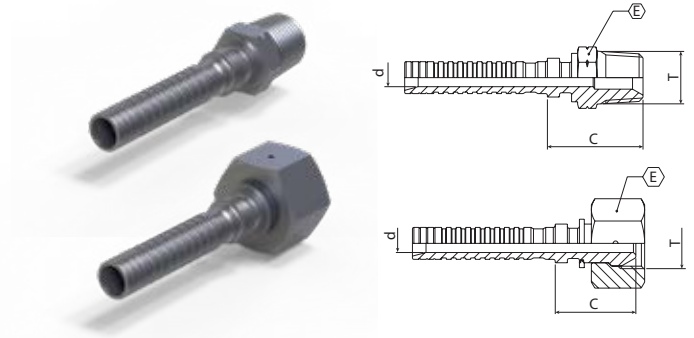

Codice / Part Nr.	Tubo / Hose	T	d	E	C	Utilizzo / Use
		Filetto / Thread	Foro / Hole	Chiave / Hexagon	Cut off	
RTPFD716J14L	1/4"	7/16"-20	3.5	15	16	Static / Dynamic
RTPFD916J14L	1/4"	9/16"-18	3.5	19	18	Static / Dynamic
RTPFD916J38L	3/8"	9/16"-18	6.5	19	18	Static / Dynamic
RTPFD34J12L	1/2"	3/4"-16	9.0	24	20	Static
RTPFD78J12L	1/2"	7/8"-14	9.0	27	21	Static

Codice / Part Nr.	Tipo / Type	Tubo / Hose	T	d	E	C	Utilizzo / Use
			Filetto / Thread	Foro / Hole	Chiave / Hexagon	Cut off	
RPF1212MTKM	FEMALE BSP	1/2"	1/2"-14	7.5	32	33.5	Dynamic
RPF1UNF12MTKM	MALE UNF	1/2"	1"-12UNF	7.5	36	34.5	Dynamic
RPMD12NPT12MTKM	MALE NPT	1/2"	1/2"-14	7.5	22	39.5	Dynamic
RPF34J12MTKM	FEMALE JIC	1/2"	3/4"-16	7.5	27	26	Dynamic

ZEC fornisce su richiesta raccordi in Acciaio Inox AISI 316L.  
Fittings are available, on request, also in AISI 316L Stainless Steel.



Istruzioni e diametri di pressatura sono disponibili e sempre aggiornati in Area Riservata sul sito ZEC: [www.zecspa.com/it/area-riservata](http://www.zecspa.com/it/area-riservata).

Crimping instructions and parameters are available and always updated on ZEC's website Reserved Area: [www.zecspa.com/en/reserved-area](http://www.zecspa.com/en/reserved-area).

## Protezione per tubi / Hose bend restrictor

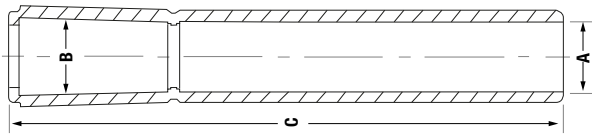

- **Descrizione:**

Manicotti di protezione in vinile di colore nero, idonei per la riduzione dello stress a flessione della tubazione nella zona della raccordatura.

- **Temperature di esercizio:**

da +5°C a +80°C (da -41°F a +176°F)

- **Description:**

Black vinyl protection sleeves, suitable to reduce hose bending stress in the crimping area.

- **Working temperature:**

from +5°C to +80°C (from -41°F to +176°F)

## Scheda tecnica - Data Sheet

Codice / Code	A (mm)	B (mm)	C (mm)
HBR10	13.2	16.0	151
HBR20	15.6	17.7	134
HBR40	17.0	19.2	146
HBR100	22.1	25.3	197





THERMOPLASTIC TUBING AND HOSES  
MADE IN ITALY

Le immagini e i valori menzionati in questo documento sono forniti a titolo puramente indicativo al fine di consentire una prima valutazione sulle possibilità di impiego dei prodotti. La Nostra produzione potrà essere variata senza impegno di alcun preavviso alla Nostra clientela.

Si raccomanda di verificare sul sito [www.zecspa.com](http://www.zecspa.com) la presenza di possibili adeguamenti per scaricare le schede tecniche di prodotto aggiornate.

**È responsabilità del cliente verificare che i tubi e i raccordi siano adatti alla propria applicazione e soddisfino le specifiche e gli standard richiesti.**

Per condizioni di vendita: [www.zecspa.com/it/condizioni-general-di-vendita](http://www.zecspa.com/it/condizioni-general-di-vendita).



Condizioni generali di vendita

*The images and values indicated in the present document are to be intended only as an indication, with the purpose of permitting the customer a first evaluation of the products application possibilities. Our production can be modified without any obligation of prior notice to our customers.*

*Therefore we recommend to consult our website [www.zecspa.com](http://www.zecspa.com) for the latest version of the technical data sheets.*

***It's the Customer's responsibility to check that hoses and fittings are suitable for his application and meet the required specifications and standards.***

*For Terms of Sale please refer to [www.zecspa.com/en/general-conditions-of-sale](http://www.zecspa.com/en/general-conditions-of-sale).*



General conditions of sale



THERMOPLASTIC TUBING AND HOSES  
MADE IN ITALY

ZEC S.p.A.  
Via Lungolorno 11, 43052 Colorno (PR) - Italy  
Tel. +39 0521 816631 - Fax +039 0521 816772

[www.zecspa.com](http://www.zecspa.com)  
[info@zecspa.com](mailto:info@zecspa.com)

